

DELTA*FLEX*

Spiral Boru & EMT Boru & Exproof Malzemeler



03



www.deltafleks.com

içindekiler / index

ALEX EMT Borular / EMT, Conduits	4-6
ALEX EMT Boru Aksesuarları / EMT Conduit Accessories	7
ALEX EMT & IMC Dahili Tip Sac Buatlar / Steel Indoor Boxes	8
ALEX IMC & RSC Borular / IMC & RSC Conduits	9
ALEX IMC & RSC Boru Aksesuarları / IMC & RSC Conduit Accessories	10
Alüminyum & Sfero Döküm Dişli Kondületler / Set Screw Aluminium & Rigid Conduit Bodies	11
Sfero Döküm Alüminyum Buatlar / Rigid Aluminium Conduit Bodies	12-13
Metal Redüksiyon / Thread Converters	14
ALEX Spiral Borular / Flexible Conduits	15
ALEX Nikel Kaplı Piriç Rakorlar / Liquid Tight Nickel Plated Brass Conduit Fittings	16
ALEX Spiral Boru Rakorları / Screw Steel & Liquid Tight Flexible Conduit Fittings	17
Kablo Rakorları & Kör Tapalar / Cable Glands & Plug	18-19
Yüksek Gerilim Kablo Kelepçeleri / HV Cable Cleats	20-22
Atkore FLEXİCON Metal Spiral Sistemler / Metallic Conduit Systems	23-26
Atkore FLEXİCON Çelik Spiral & Rakorları / PVC Coated Steel Conduit & Fitting	27-28
Atkore FLEXİCON LTP Harici Tip Spiraller ve Rakorları / Liquid Type Conduits & Fittings	29
Atkore FLEXİCON Polyamid Spiral ve Rakorları / Polyamide Flexible Conduits & Fittings	30-34
Atkore FLEXİCON Raylı Sistem Kablo Koruma Spiralleri / Cable Protection Systems For Rail	35-36
Exproof Elektrik Malzemeleri / Exproof Electrical Equipments	37-43
PVC Boru Spiral & Aksesuarları / PVC Rigid - Flexible Conduit & Accessories	44-46
HAGER BERKER Anahtar Piriz Sistemleri / Switch & Socket Systems	47-52
Özel Tasarım Prizler / Custom Design Sockets	53
Paslanmaz Çelik Elektrik Malzemeleri / Stainless Steel Electrical Materials	54
Teknik Bilgiler Diş Tip Özellikleri - Çevrim Tabloları / IP Koruma Dereceleri	55

ALEX CONDUIT

 **EMT - IMC BORU RAKORLARI & AKSESUARLARI**
EMT - IMC CONDUIT FITTINGS & ACCESSORIES

www.deltafleks.com
info@deltafleks.com



Malzeme: 1. Çelik üzeri Pregalvaniz kaplı
2. Galvaniz üzeri fırın boyalı olabilir
3. UL Sertifikalıdır

Standart: UL 797

Sertifika No: E343501

***Elektrik tesisatlarında, kablo koruyucu olarak kullanılan çapaksız dışsız borulardır.**

ÖLÇÜ Trade Size		DIŞ ÇAP Outside Diameter		İÇ ÇAP Inside Diameter		NOMİNAL ET KALINLIĞI Minimum Wall Thick- ness		STANDART AĞIRLIK Standart Weight		Uzunluk 10 ft
inch	metrik	inch	mm	inch	mm	inch	mm	lbs/ft	kg/m	mm
EMT1 1/2"	15	0.706	17,93	0,622	15,80	0,042	1,07	0,285	0,424	3048
EMT2 3/4"	20	0.922	23,42	0,824	20,93	0,049	1,25	0,435	0,647	3048
EMT3 1"	25	1.163	29,54	1,049	26,64	0,057	1,45	0,640	0,952	3048
EMT4 1-1/4"	32	1,510	38,35	1,380	35,05	0,065	1,65	0,950	1,414	3048
EMT5 1-1/2"	40	1,740	44,20	1,610	40,89	0,065	1,65	1,10	1,637	3048
EMT6 2"	50	2,197	55,80	2,067	52,50	0,065	1,65	1,40	2,083	3048
EMT7 2 1/2"	65	2,875	73,03	2,731	69,37	0,072	1,83	2,16	3,21	3048
EMT8 3"	80	3,500	88,90	3,356	85,24	0,072	1,83	2,63	3,90	3048
EMT9 3 1/2"	90	4000	101,60	3,834	97,38	0,083	2,11	3,49	5,19	3048
EMT10 4"	100	4500	114,30	4,334	110,08	0,083	2,11	3,93	5,84	3048



Malzeme: 1. Çelik üzeri Hot Deep Galvaniz kaplı
2. UL Sertifikalıdır

Standart: UL 797

Sertifika No: E343501

***Elektrik tesisatlarında, kablo koruyucu olarak kullanılan çapaksız dışsız borulardır.**

ÖLÇÜ Trade Size		DIŞ ÇAP Outside Diameter		İÇ ÇAP Inside Diameter		NOMİNAL ET KALINLIĞI Minimum Wall Thick- ness		STANDART AĞIRLIK Standart Weight		Uzunluk 10 ft
inch	metrik	inch	mm	inch	mm	inch	mm	lbs/ft	kg/m	mm
EMTH1 1/2"	15	0.706	17,93	0,622	15,80	0,042	1,07	0,285	0,424	3048
EMTH2 3/4"	20	0.922	23,42	0,824	20,93	0,049	1,25	0,435	0,647	3048
EMTH3 1"	25	1.163	29,54	1,049	26,64	0,057	1,45	0,640	0,952	3048
EMTH4 1-1/4"	32	1,510	38,35	1,380	35,05	0,065	1,65	0,950	1,414	3048
EMTH5 1-1/2"	40	1,740	44,20	1,610	40,89	0,065	1,65	1,10	1,637	3048
EMTH6 2"	50	2,197	55,80	2,067	52,50	0,065	1,65	1,40	2,083	3048
EMTH7 2 1/2"	65	2,875	73,03	2,731	69,37	0,072	1,83	2,16	3,21	3048
EMTH8 3"	80	3,500	88,90	3,356	85,24	0,072	1,83	2,63	3,90	3048
EMTH9 3 1/2"	90	4000	101,60	3,834	97,38	0,083	2,11	3,49	5,19	3048
EMTH10 4"	100	4500	114,30	4,334	110,08	0,083	2,11	3,93	5,84	3048



ÜRÜN KODU	ÇAP
DE 501	1/2"
DE 502	3/4"
DE 503	1"
DE 504	1 1/4"
DE 505	1 1/2"
DE 506	2"

Vidalı Buat Rakoru / *Connectors*



Materyal: Zamak veya çelik / Zinc die - cast or steel
Sertifika: UL, / Certificate: UL
Standart: 514B



ÜRÜN KODU	ÇAP
DE 511	1/2"
DE 512	3/4"
DE 513	1"
DE 514	1 1/4"
DE 515	1 1/2"
DE 516	2"

Vidalı Boru Mufu / *Couplings*



Materyal: Zamak veya çelik / Zinc die - cast or steel
Sertifika: UL, / Certificate: UL
Standart: 514B



ÜRÜN KODU	ÇAP
DE 601	1/2"
DE 602	3/4"
DE 603	1"
DE 604	1 1/4"
DE 605	1 1/2"
DE 606	2"

Sıkmalı Buat Rakoru
Compression Connectors



Materyal: Zamak veya çelik / Zinc die - cast or steel
Sertifika: UL, / Certificate: UL
Standart: 514B



ÜRÜN KODU	ÇAP
DE 611	1/2"
DE 612	3/4"
DE 613	1"
DE 614	1 1/4"
DE 615	1 1/2"
DE 616	2"

Sıkmalı Buat Mufu
Couplings Compression



Materyal: Zamak veya çelik / Zinc die - cast or steel
Sertifika: UL, / Certificate: UL
Standart: 514B



ÜRÜN KODU	ÇAP
DE 601 S	1/2"
DE 602 S	3/4"
DE 603 S	1"
DE 604 S	1 1/4"
DE 605 S	1 1/2"
DE 606 S	2"

Sıkmalı Çelik Buat Rakoru
Compression Steel Connectors



Materyal: Galvanizli çelik / Galvanised steel
Sertifika: UL, / Certificate: UL
Standart: 514B



ÜRÜN KODU	ÇAP
DE 611 S	1/2"
DE 612 S	3/4"
DE 613 S	1"
DE 614 S	1 1/4"
DE 615 S	1 1/2"
DE 616 S	2"

Sıkmalı Çelik Buat Mufu
Couplings Steel Compression



Materyal: Galvanizli çelik / Galvanised steel
Sertifika: UL, / Certificate: UL
Standart: 514B



ÜRÜN KODU	ÇAP
DE 531	1/2"
DE 532	3/4"
DE 533	1"
DE 534	1 1/4"
DE 535	1 1/2"
DE 536	2"

EMT Kroşe Tek Delikli
Straps One Hole



Materyal: Galvanizli çelik / Galvanised steel
Sertifika: UL, / Certificate: UL
Standart: 514B



ÜRÜN KODU	ÇAP
DE 521	1/2"
DE 522	3/4"
DE 523	1"
DE 524	1 1/4"
DE 525	1 1/2"
DE 526	2"

EMT Kroşe Çift Delikli
Straps Two Holes



Materyal: Galvanizli çelik / Galvanised steel
Sertifika: UL, / Certificate: UL
Standart: 514B



ÜRÜN KODU	ÇAP
DE 6011	1/2"
DE 6021	3/4"
DE 6031	1"
DE 6041	1 1/4"
DE 6051	1 1/2"
DE 6061	2"

Boru Taşıma Kelepçesi
Conduit Hangers



Materyal: Galvanizli çelik / Galvanised steel
Sertifika: UL, / Certificate: UL
Standart: 514B



ÜRÜN KODU	ÇAP
DE 2101	1/2"
DE 2102	3/4"
DE 2103	1"
DE 2104	1 1/4"
DE 2105	1 1/2"
DE 2106	2"

Tırnaklı Boru Kelepçesi
Strut Clamps



Materyal: Galvanizli çelik / Galvanised steel
Sertifika: UL, / Certificate: UL
Standart: 514B



ÜRÜN KODU	ÇAP
DE 81	1/2"
DE 82	3/4"
DE 83	1"
DE 84	1 1/4"
DE 85	1 1/2"
DE 86	2"

EMT 90° Dirsek/ Elbow



Materyal: Galvanizli çelik / Galvanised steel
Sertifika: UL, / Certificate: UL
Standart: 514B



ÜRÜN KODU	ÇAP
ALX 351	1/2"
ALX 352	3/4"
ALX 353	1"
ALX 354	1 1/4"

Kapaklı Dişli Dirsek
Rigid Pull Elbow



Materyal: Zamak veya çelik / Zinc die - cast or steel
Sertifika: UL, / Certificate: UL
Standart: 514B



ÜRÜN KODU	ÇAP
KD 1/2"	1/2"
KD 3/4"	3/4"
KD 1/2"	1/2"

Kısa T - 90° Dirsek
Short T Connector & Elbow



Materyal: Nikel kaplı bakır / Nickel coated copper
Kullanım Alanı: EMT boruların köşe dönüşlerinde kullanılır.



ÜRÜN KODU	ÇAP
ALX - 341	1/2"
ALX - 342	3/4"

Vidalı - 90° Dirsek
Insider Corner Set Screw Type



Materyal: Zamak veya çelik / Zinc die - cast or steel
Sertifika: UL, / Certificate: UL



ÜRÜN KODU	ÇAP
DE 791	1/2"
DE 792	3/4"
DE 793	1"

Vidalı Açılı Dirsek
Offset Connector



KODU	ÖLÇÜ	KODU	ÖLÇÜ
RB1	1/2"-3/8"	RB9	1 1/2"-3/4"
RB2	3/4"-1/2"	RB10	1 1/2"-1"
RB3	1"-1/2"	RB11	1 1/2"-1 1/4"
RB4	1"-3/4"	RB12	2"-1/2"
RB5	1 1/4"-1/2"	RB13	2"-3/4"
RB6	1 1/4"-3/4"	RB14	2"-1"
RB7	1 1/4"-1"	RB15	2"-1 1/4"
RB8	1 1/2"-1/2"	RB16	2"-1/2"

Redüksiyon
Reducing Bushings





ÜRÜN KODU	ÇAP
301S	1/2"
302S	3/4"
303S	1"
304S	1 1/4"
305S	1 1/2"
306S	2"
307S	2 1/2"
308S	3"
309S	4"

Kilitleme Somunu Çelik
Steel Locknuts



ÜRÜN PVC	ÖLÇÜ	ÜRÜN LASTİK
DENT050	1/2"	DENT 1/2"
DENT075	3/4"	DENT 3/4"
DENT100	1"	DENT 1"
DENT125	1 1/4"	DENT 1 1/4"
DENT150	1 1/2"	DENT 1 1/2"
DENT200	2"	DENT 2"
DENT250	2 1/2"	DENT 2 1/2"
DENT300	3"	DENT 3"

PVC Entül EMT-IMC
PVC Ende Cup



ÜRÜN KODU	ÇAP Ø (mm)	kg/pcs
BC-08	M8	0,10
BC-10	M10	0,16
BC-12	M12	0,26

Tij Askı Mengenesi
Beam Clamps



ÜRÜN KODU	ÇAP
GL-840H	1/2"
GL-841H	3/4"
GL-842H	1"

Boru Bükme Aparatı
Bender



ÜRÜN KODU	ÇAP
281	1/2"
282	3/4"
283	1"
284	1 1/4"
285	1 1/2"
286	2"
287	2 1/2"
288	3"
289	4"

Metal Bushing
Mettalic Bushings



ÜRÜN KODU	ÇAP
281-TB	1/2"
282-TB	3/4"
283-TB	1"
284-TB	1 1/4"
285-TB	1 1/2"
286-TB	2"
287-TB	2 1/2"
288-TB	3"
289-TB	3 1/2"
290-TB	4"

Topraklamalı Metal Bushing
Grounding Mettalic Bushing



ÜRÜN KODU	ÇAP
281P	1/2"
282P	3/4"
283P	1"
284P	1 1/4"
285P	1 1/2"
286P	2"
287P	2 1/2"
288P	3"
289P	4"

Plastik Bushing
PVC Bushings



SOMUNLU ÜRÜN KODU	ÖLÇÜ	TRİFONLU ÜRÜN KODU	ÖLÇÜ
DBK	1/2"	DBKT	1/2"
DBK	3/4"	DBKT	3/4"
DBK	1"	DBKT	1"
DBK	1 1/4"	DBKT	1 1/4"
DBK	1 1/2"	DBKT	1 1/2"
DBK	2"	DBKT	2"
DBK	2 1/2"	DBKT	2 1/2"
DBK	3"	DBKT	3"

Somunlu & Trifonlu Kelepçe
Bolt & Nut Clamps





ÜRÜN KODU	Delik Sayısı
52151	12x1/2"
52152	8x3/4"
52153	8x1/2" & 4x3/4"

Kare Buat / 4" Square Boxes
102x102x38 / 1-1/2 deep



ÜRÜN KODU	Delik Sayısı
52171	12x1/2"
52172	8x3/4"
52173	8x1/2" & 4x3/4"
52174	8x1"

Kare Buat / 4" Square Boxes
102x102x54 / 2-1/8 deep



ÜRÜN KODU	Delik Sayısı
72171	12x1/2"
72172	8x3/4"
72173	8x1/2" & 4x3/4"
72174	8x1"

Kare Buat / 4-11/16" Square Boxes
120x120x54 / 2-1/8 deep



ÜRÜN KODU	Delik Sayısı
58361	8x1/2"
58362	6x3/4"
58363	4x1/2" & 4x3/4"

Dikdörtgen Buat / Rectangular Boxes
102x54x48 / 2-1/8 x1-7/8 deep



ÜRÜN KODU	Delik Sayısı
54151	4x1/2"
54152	4x3/4"
54153	2x1/2" & 2x3/4"

8 Köşeli Buat / 4" Octagonal Boxes
90x90x38 / 1-1/2 deep



ÜRÜN KODU	Delik Sayısı
54171	4x1/2"
54172	4x3/4"
54173	2x1/2" & 2x3/4"

8 Köşeli Buat / 4" Octagonal Boxes
90x90x54 / 1-1/8 deep



TANIM / DERİNLİK	ÜRÜN KODU
35mm Tekli	ALX-013301
35mm Çiftli	ALX-013601
47mm Tekli	ALX-033001
47mm Çiftli	ALX-036001

BS Kasa / BS Switch Box
20x25mm ko's



ÜRÜN KODU	ÖLÇÜ
5 HOLES	
RB50-5	1/2"
RB75-5	3/4"

Yuvarlak Buat
4" Round Extension & Rings Box



ÜRÜN KODU	ÖLÇÜ
TGB 50-3	1/2"x3
TGB 50-5	1/2"x5
TGB 75-3	3/4"x3
TGB 75-5	3/4"x5
TGB 75-7	3/4"x7
DTB 100-5	1"x5
2BC-A	Kapak

Harici Buat Çiftli IP66
Two Gang Weatherproof Boxes



ÜRÜN KODU	ÖLÇÜ
FSB 50-3	1/2"x3
FSB 50-5	1/2"x5
FSB 75-3	3/4"x3
FSB 75-5	3/4"x5
1BC-A	Kapak

Harici Buat Tekli IP66
One Gang Weatherproof Boxes



Materyal: Alüminyum döküm / Die cast Aluminum
Sertifika: UL, / Certificate: UL
Standart: 514B

Materyal: Alüminyum döküm / Die cast Aluminum
Sertifika: UL, / Certificate: UL
Standart: 514B

IMC BORU / Intermediate Metallic Conduit

ANSI C80.6

UL 1242-1983



- Malzeme:** 1. Çelik üzeri Hot Deep Galvaniz kaplı
2. Çelik üzeri Pregalvaniz kaplı
3. Galvaniz üzeri fırın boyalı

Standart: UL 1243-1983

Sertifika No: E471156

***Elektrik tesisatlarında, kablo koruyucu olarak kullanılan çapaksız dişli borulardır.**

ÖLÇÜ Trade Size		DIŞ ÇAP Outside Diameter N o m i n a l		UZUNLUK (MANŞONLU) Lenght with Coupling		ET KALINLIĞI Min. Wall Thickness		AĞIRLIK Nominal Weight per 100ft	
inch	Metrik	inch	mm	inch	mm	inch	mm	lb	Kg
IMC21 1/2"	15	0.815	20.7	9' - 11 - 1/4"	3029,0	0,070	1,78	62,0	28,1
IMC2 3/4"	20	1.029	26.1	9' - 11 - 1/4"	3029,0	0,075	1,91	85,3	38,7
IMC3 1"	25	1.290	32.8	9' - 11	3022,6	0,085	2,16	125,4	56,9
IMC4 1-1/4"	32	1.638	41.6	9' - 11	3022,6	0,085	2,16	162,0	73,5
IMC5 1-1/2"	40	1.883	47.8	9' - 11	3022,6	0,090	2,29	187,8	85,2
IMC6 2"	50	2.360	59.9	9' - 11	3022,6	0,095	2,41	251,5	114,1
IMC7 2-1/2"	65	2.857	72.6	9' - 10 - 1/2"	3009,9	0,140	3,56	400,6	181,7
IMC8 3"	80	3.476	88.3	9' - 10 - 1/2"	3009,9	0,140	3,56	491,8	223,1
IMC9 3-1/2"	90	3.971	100.9	9' - 10 - 1/4"	3003,6	0,140	3,56	564,7	256,1
IMC10 4"	100	4.466	113.3	9' - 10 - 1/4"	3003,9	0,140	3,56	634,4	291,2

RSC BORU / Rigid Steel Conduit

ANSI C80.1

UL 6



- Malzeme:** 1. Çelik üzeri Hot Deep Galvaniz kaplı
2. Çelik üzeri Pregalvaniz kaplı
3. Galvaniz üzeri fırın boyalı

Standart: UL 6

***Elektrik tesisatlarında, kablo koruyucu olarak kullanılan çapaksız dişli borulardır.**

ÖLÇÜ Trade Size		DIŞ ÇAP Outside Diameter Nominal		UZUNLUK (MANŞONLU) Lenght with Coupling		ET KALINLIĞI Min. Wall Thickness		AĞIRLIK Nominal Weight per 100ft	
inch	Metrik	mm	inch	inch	mm	mm	inch	lb	Kg
RSC1 1/2"	16	21,3	0,840	9' - 11 - 1/4"	3030	2,64	0,104	82	37,2
RSC2 3/4"	21	26,7	1,050	9' - 11 - 1/4"	3030	2,72	0,107	109	49,4
RSC3 1"	27	33,4	1,315	9' - 11	3025	3,20	0,126	161	73,0
RSC4 1-1/4"	35	42,2	1,660	9' - 11	3025	3,38	0,133	218	98,9
RSC5 1-1/2"	41	48,3	1,900	9' - 11	3025	3,51	0,138	263	119,3
RSC6 2"	53	60,3	2,375	9' - 11	3025	3,71	0,146	350	158,7
RSC7 2-1/2"	63	73,0	2,875	9' - 10 - 1/2"	3010	4,90	0,193	559	253,5
RSC8 3"	78	88,9	3,500	9' - 10 - 1/2"	3010	5,21	0,205	727	329,7
RSC9 3-1/2"	91	101,6	4,000	9' - 10 - 1/4"	3005	5,46	0,215	880	399,1
RSC10 4"	103	114,3	4,500	9' - 10 - 1/4"	3005	5,72	0,225	1030	467,1



ÜRÜN KODU	ÇAP
DHB1	1/2"
DHB2	3/4"
DHB3	1"
DHB4	1 1/4"
DHB5	1 1/2"
DHB6	2"
DHB7	2 1/2"
DHB8	3"
DHB9	4"

3 Parçalı Muf
3 Pieces Coupling



ÜRÜN KODU	ÇAP
ALX-851	1/2"
ALX-852	3/4"
ALX-853	1"
ALX-854	1 1/4"
ALX-855	1 1/2"
ALX-856	2"
ALX-857	2 1/2"
ALX-858	3"
ALX-859	3 1/2"

3 Parçalı Muf
3 Pieces Coupling



ÜRÜN KODU	ÇAP
DE551	1/2"
DE552	3/4"
DE553	1"
DE554	1 1/4"
DE555	1 1/2"
DE556	2"

IMC Kroşe Tek Delikli
Straps One Holes



ÜRÜN KODU	ÇAP
DE561	1/2"
DE562	3/4"
DE563	1"
DE564	1 1/4"
DE565	1 1/2"
DE566	2"

IMC Kroşe Çift Delikli
Straps Two Holes



ÜRÜN KODU	ÇAP
DN51	1/2"
DM52	3/4"
DM53	1"
DM54	1 1/4"
DM55	1 1/2"
DM56	2"
DM57	2 1/2"
DM58	3"
DM59	4"

Manşon / Couplings



ÜRÜN KODU	ÇAP
NP1	1/2"
NP2	3/4"
NP3	1"
NP4	1 1/4"
NP5	1 1/2"
NP6	2"

Nipel / Nipple



ÜRÜN KODU	ÇAP
DE61	1/2"
DE62	3/4"
DE63	1"
DE64	1 1/4"
DE65	1 1/2"
DE66	2"

IMC 90° Dirsek/ Elbow



ÜRÜN KODU	ÇAP (inch)
UB050	1/2"
UB075	3/4"
UB100	1"
UB125	1 1/4"
UB150	1 1/2"
UB200	2"
UB250	2 1/2"
UB300	3"
UB400	4"

U - Bolt / U - Bolts





Aluminyum

Dişli Kondület LL IP66 /Rigid Conduit Bodies

ÜRÜN KODU	ÇAP
LL1	1/2"
LL2	3/4"
LL3	1"
LL4	1 1/4"
LL5	1 1/2"
LL6	2"



Sfero

Dişli Kondület LL - LR IP66 /
Rigid Conduit Bodies

ÜRÜN KODU	ÇAP
SDL1 SDR1	1/2"
SDL2 SDR2	3/4"
SDL3 SDR3	1"
SDL4 SDR4	1 1/4"
SDL5 SDR5	1 1/2"
SDL6 SDR6	2"



Aluminyum

Dişli Kondület LB IP66 /Rigid Conduit Bodies

ÜRÜN KODU	ÇAP
LB1	1/2"
LB2	3/4"
LB3	1"
LB4	1 1/4"
LB5	1 1/2"
LB6	2"



Sfero

Dişli Kondület SDB IP66 /Rigid Conduit Bodies

ÜRÜN KODU	ÇAP
SDB1	1/2"
SDB2	3/4"
SDB3	1"
SDB4	1 1/4"
SDB5	1 1/2"
SDB6	2"



Aluminyum

Dişli Kondület LR IP66/Rigid Conduit Bodies

ÜRÜN KODU	ÇAP
LR1	1/2"
LR2	3/4"
LR3	1"
LR4	1 1/4"
LR5	1 1/2"
LR6	2"



Sfero

Dişli Kondület X IP66/Rigid Conduit Bodies

ÜRÜN KODU	ÇAP
X1	1/2"
X2	3/4"
X3	1"
X4	1 1/4"
X5	1 1/2"
X6	2"



Aluminyum

Dişli Kondület T IP66 /Rigid Conduit Bodies

ÜRÜN KODU	ÇAP
T1	1/2"
T2	3/4"
T3	1"
T4	1 1/4"
T5	1 1/2"
T6	2"



Sfero

Dişli Kondület T IP66 /Rigid Conduit Bodies

ÜRÜN KODU	ÇAP
SDT1	1/2"
SDT2	3/4"
SDT3	1"
SDT4	1 1/4"
SDT5	1 1/2"
SDT6	2"



Aluminyum

Dişli Kondület C IP66 /Rigid Conduit Bodies

ÜRÜN KODU	ÇAP
C1	1/2"
C2	3/4"
C3	1"
C4	1 1/4"
C5	1 1/2"
C6	2"



Sfero

Dişli Kondület C IP66 /Rigid Conduit Bodies

ÜRÜN KODU	ÇAP
SDC1	1/2"
SDC2	3/4"
SDC3	1"
SDC4	1 1/4"
SDC5	1 1/2"
SDC6	2"



GRFC Tip Döküm Buat
Malleible Iron Box



ÜRÜN KODU	ÇAP	ÖLÇÜLER
GRFC-119	1/2"	42
GRFC-219	3/4"	42
GRFC-129	1/2"	62
GRFC-229	3/4"	62
GRFC-329	1"	62
GRFC-139	1/2"	82
GRFC-239	3/4"	82
GRFC-339	1"	82



GRFT Tip Döküm Buat
Malleible Iron Box



ÜRÜN KODU	ÇAP	ÖLÇÜLER
GRFT-119	1/2"	42
GRFT-219	3/4"	42
GRFT-129	1/2"	62
GRFT-229	3/4"	62
GRFT-329	1"	62
GRFT-139	1/2"	82
GRFT-239	3/4"	82
GRFT-339	1"	82



GRFL Tip Döküm Buat
Malleible Iron Box



ÜRÜN KODU	ÇAP	ÖLÇÜLER
GRFL-119	1/2"	42
GRFL-219	3/4"	42
GRFL-129	1/2"	62
GRFL-229	3/4"	62
GRFL-329	1"	62
GRFL-139	1/2"	82
GRFL-239	3/4"	82
GRFL-339	1"	82



GRFX Tip Döküm Buat
Malleible Iron Box



ÜRÜN KODU	ÇAP	ÖLÇÜLER
GRFX-119	1/2"	42
GRFX-219	3/4"	42
GRFX-129	1/2"	62
GRFX-229	3/4"	62
GRFX-329	1"	62
GRFX-139	1/2"	82
GRFX-239	3/4"	82
GRFX-339	1"	82

GENEL ÖZELLİKLER

- Tüm GS.. tip döküm buatların derinlikleri 52 mm'dir.(Dıştan dışa)
- Tüm GRF.. tip döküm buatların çapları 116 mm'dir.(Dıştan dışa)
- Yerli imalatlarımızda, özellikle (ERENCO) Demir Çelik İşletmeleri standartları dikkate alınmaktadır.
- Standart fittings imalatlarımız 4" 'e kadar olup, istek üzerine 6" 'e kadar da imalat yapılabilir.
- Tüm buatlar contalı ve paslanmaz vidalı olup, değişik tiplerde USA veya AVRUPA standartlarında üretilebilir.
- Kapaklı buatların değişik çıkışlı tipleri olup, bütün çıkışlarına istenilen dış özelliğinde üretim de yapılabilir.
- İlgili listelerde gas dış olarak belirtilen bazı aksesuarların, istenildiği takdirde Pg, Metrik ve NPT dış olarakta imalatı yapılabilir.



GSC Tip Ayaklı - Ayaksız
Döküm Buatlar



AYAKSIZ	AYAKLI	ÇAP	ÖLÇÜLER
GSC-110	GSC-119	1/2"	90
GSC-210	GSC-219	3/4"	90
GSC-310	GSC-319	1"	90
GSC-410	---	1 1/4"	90
GSC-510	---	1 1/2"	90
GSC-610	---	2"	90
GSC-120	GSC-129	1/2"	122
GSC-220	GSC-229	3/4"	122
GSC-320	GSC-329	1"	122



GSL Tip Ayaklı - Ayaksız
Döküm Buatlar



AYAKSIZ	AYAKLI	ÇAP	ÖLÇÜLER
GSL-110	GSL-119	1/2"	90
GSL-210	GSL-219	3/4"	90
GSL-310	GSL-319	1"	90
GSL-410	---	1 1/4"	90
GSL-510	---	1 1/2"	90
GSL-610	---	2"	90
GSL-120	GSL-129	1/2"	122
GSL-220	GSL-229	3/4"	122
GSL-320	GSL-329	1"	122



GST Tip Ayaklı - Ayaksız
Döküm Buatlar



AYAKSIZ	AYAKLI	ÇAP	ÖLÇÜLER
GST-110	GST-119	1/2"	90
GST-210	GST-219	3/4"	90
GST-310	GST-319	1"	90
GST-410	---	1 1/4"	90
GST-510	---	1 1/2"	90
GST-610	---	2"	90
GST-120	GST-129	1/2"	122
GST-220	GST-229	3/4"	122
GST-320	GST-329	1"	122



GSX Tip Ayaklı - Ayaksız
Döküm Buatlar



AYAKSIZ	AYAKLI	ÇAP	ÖLÇÜLER
GSX-110	GSX-119	1/2"	90
GSX-210	GSX-219	3/4"	90
GSX-310	GSX-319	1"	90
GSX-410	---	1 1/4"	90
GSX-510	---	1 1/2"	90
GSX-610	---	2"	90
GSX-120	GSX129	1/2"	122
GSX-220	GSX-229	3/4"	122
GSX-320	GSX-329	1"	122



GS Tip Ayaklı - Ayaksız
Döküm Buatlar



AYAKSIZ	AYAKLI	ÇAP	ÖLÇÜLER
GS-110	GS-119	1/2"	90
GS-210	GS-219	3/4"	90
GS-310	GS-319	1"	90
GS-410	---	1 1/4"	90
GS-510	---	1 1/2"	90
GS-610	---	2"	90
GS-120	GS129	1/2"	122
GS-220	GS-229	3/4"	122
GS-320	GS-329	1"	122



ÜRÜN KODU	AÇIKLAMA	ÖLÇÜ	KORUMA SINIFI
ADB727257	ALÜMİNYUM BUAT	72x72x57	IP67
ADB721157	ALÜMİNYUM BUAT	72x112x57	IP67
ADB721457	ALÜMİNYUM BUAT	72x142x57	IP67
ADB101080	ALÜMİNYUM BUAT	100x100x80	IP67
ADB101380	ALÜMİNYUM BUAT	100x130x80	IP67
ADB131390	ALÜMİNYUM BUAT	130x130x90	IP67
ADB131990	ALÜMİNYUM BUAT	130x190x90	IP67
ADB161690	ALÜMİNYUM BUAT	160x160x90	IP67
ADB171990	ALÜMİNYUM BUAT	170x190x90	IP67
ADB192590	ALÜMİNYUM BUAT	190x250x90	IP67
ADB232811	ALÜMİNYUM BUAT	230x280x110	IP67
915.0600	ALÜMİNYUM BUAT	230x330x140	IP67
917.0600	ALÜMİNYUM BUAT	233x410x110	IP67
919.0600	ALÜMİNYUM BUAT	315x410x160	IP67

Alüminyum Buatlar
Aluminum Boxes



Uzun - Kısa Tip / Long - Short



GAZ DİŞ METRİK	METRİK GAZ DİŞ	DİŞ BÜYÜTME GAZ - GAZ	DİŞ KÜÇÜLTME GAZ - GAZ
B/3/8' - M16	B/M16 - 1/2'	B-1/2' - 1/4'	B1/4' - 3/8'
B/1/2' - M16	B/M20 - 1/2'	B-1/2' - 3/8'	B-3/8' - 1/4'
B/1/2' - M20	B/M20 - 3/4'	B-1/2' - 3/4'	B-3/8' - 1/2'
B/1/2' - M25	B/M25 - 1/2'	B-11/4' - 1/2'	B-3/4' - 3/8'
B/3/4' - M20	B/M25 - 3/4'	B-11/4' - 3/4'	B-3/4' - 1/2'
B/3/4' - M25	B/M32 - 3/4'	B-11/4' - 1'	B-3/4' - 1'
B/3/4' - M32	B/M32 - 1'	B-11/4' - 11/2'	B-1' - 1/2'
B/1' - M20	B/M40 - 1'	B-11/2' - 3/4'	B-1' - 3/4'
B/1' - M25	B/M40 - 11/4'	B-11/2' - 1'	B-1' - 11/4'
B/1' - M32	B/M50 - 11/2'	B-2' - 3/4'	
B/11/4' - M40	B/M50 - 2'	B-2' - 1'	
B/11/2' - M50	B/M63 - 11/2'	B-2' - 11/4'	
B/11/2' - M63	B/M63 - 2'		
B/2' - M50	B/M75 - 2'		
B/2' - M63	B/M75 - 21/2'		

METRİK - PG	PG - METRİK	DİŞ KÜÇÜLTME M - M	DİŞ BÜYÜTME M - M
B/M12 - PG7	B/PG7 - M16	B-M12 - M16	B-M16 - M12
B/M12 - PG9	B/PG9 - M16	B-M16 - M20	B-M20 - M12
B/M16 - PG7	B/PG9 - M20	B-M16 - M25	B-M20 - M16
B/M16 - PG9	B/PG11 - M16	B-M16 - M32	B-M25 - M16
B/M16 - PG11	B/PG11 - M20	B-M18 - M20	B-M25 - M20
B/M16 - PG13	B/PG13 - M16	B-M20 - M25	B-M32 - M16
B/M20 - PG7	B/PG13 - M20	B-M25 - M32	B-M32 - M20
B/M20 - PG9	B/PG13 - M25	B-M32 - M40	B-M32 - M25
B/M20 - PG11	B/PG16 - M16	B-M40 - M50	B-M40 - M16
B/M20 - PG13	B/PG16 - M20	B-M50 - M63	B-M40 - M20
B/M20 - PG16	B/PG16 - M25		B-M40 - M25
B/M20 - PG21	B/PG21 - M20		B-M40 - M32
B/M25 - PG13	B/PG21 - M25		B-M50 - M16
B/M25 - PG16	B/PG21 - M32		B-M50 - M20
B/M25 - PG21	B/PG29 - M20		B-M50 - M25
B/M32 - PG16	B/PG29 - M25		B-M50 - M32
B/M32 - PG21	B/PG29 - M32		B-M50 - M40

DİŞ KÜÇÜLTME PG - PG ERKEK DİŞ	DİŞ BÜYÜTME PG - PG	GAZ DİŞ - PG	PG - GAZ DİŞ
B/PG7 - PG9	B/PG9 - PG16	B/1/2' - PG11	B/PG11 - 1/2'
B/PG9 - PG11	B/PG11 - PG7	B/1/2' - PG13	B/PG13 - 1/2'
B/PG9 - PG13	B/PG11 - PG9	B/1/2' - PG16	B/PG16 - 3/4'
B/PG11 - PG13	B/PG13 - PG7	B/3/4' - PG7	B/PG21 - 3/4'
B/PG11 - PG16	B/PG13 - PG9	B/3/4' - PG11	B/PG21 - 1'
B/PG13 - PG16	B/PG13 - PG11	B/3/4' - PG13	B/PG29 - 1'
B/PG13 - PG21	B/PG16 - PG7	B/3/4' - PG16	B/PG36 - 11/4'
B/PG16 - PG21	B/PG16 - PG11	B/3/4' - PG21	B/PG36 - 11/2'
B/PG21 - PG29	B/PG16 - PG13	B/1' - PG16	B/PG42 - 11/2'
B/PG29 - PG36	B/PG21 - PG11	B/1' - PG29	B/PG48 - 2'
B/PG36 - PG42	B/PG21 - PG13	B/11/4' - PG36	
B/PG42 - PG48	B/PG21 - PG16	B/11/2' - PG42	



JS Galvaniz Çelik Spiral
Galvanized Conduit



ÜRÜN KODU	ÖLÇÜ	İÇ ÇAP (mm)	DIŞ ÇAP (mm)	RULO UZUNLUĞU (mt)
JS12	3/8"	13	16	50
JS15	1/2"	16	20	50
JS20	3/4"	21	25	50
JS25	1"	26	31	50
JS32	1 1/4"	35	40	30
JS38	1 1/2"	40	46	30
JS51	2"	52	57	20
JS64	2 1/2"	63	71	15
JS75	3"	78	86	15
JS100	4"	102	109	10



JSH PVC Kaplı Çelik Spiral
PVC Coated Conduit



ÜRÜN KODU	ÖLÇÜ	İÇ ÇAP (mm)	DIŞ ÇAP (mm)	RULO UZUNLUĞU (mt)
JSH12	3/8"	13	17	50
JSH15	1/2"	16	21	50
JSH20	3/4"	21	26	50
JSH25	1"	26	32	50
JSH32	1 1/4"	35	41	30
JSH38	1 1/2"	40	47	30
JSH51	2"	52	59	20
JSH64	2 1/2"	63	72	15
JSH75	3"	78	88	15
JSH100	4"	102	112	10



JSBH Harici Tip Çelik Spiral
Liquid Tight Conduit



ÜRÜN KODU	ÖLÇÜ	İÇ ÇAP mm	DIŞ ÇAP mm	RULO UZUNLUĞU mt
JSBH12	3/8"	13	18	50
JSBH15	1/2"	16	21	50
JSBH20	3/4"	21	26	50
JSBH25	1"	26	33	50
JSBH32	1 1/4"	35	42	30
JSBH38	1 1/2"	40	48	30
JSBH51	2"	52	60	20
JSBH64	2 1/2"	63	73	15
JSBH75	3"	78	89	15
JSBH100	4"	102	114	10



FJ Çelik Örgülü Spiral
Galvanized Steel Braided



ÜRÜN KODU	ÖLÇÜ	İÇ ÇAP mm	DIŞ ÇAP mm	RULO UZUNLUĞU mt
FJS10	1/4"	10	14,5	50
FJS12	3/8"	12	16,5	50
FJS15	1/2"	16	20	50
FJS20	3/4"	21	25	50
FJS25	1"	26	31	50
FJS32	1 1/4"	30	43	30
FJS38	1 1/2"	38	46	30
FJS51	2"	50,5	58,5	20
FJS64	2 1/2"	62,9	72,1	15

HARİCİ TIP NİKEL KAPLI PİRİNÇ RAKORLAR

LIQUID TIGHT NICKEL PLATED BRASS CONNECTORS



FJSH PVC Kaplı Çelik Örgülü
Spiral
PVC Coated Steel Braided



ÜRÜN KODU	ÖLÇÜ	İÇ ÇAP mm	DIŞ ÇAP mm	RULO UZUNLUĞU mt
FJSH10	1/4"	10	15,5	50
FJSH12	3/8"	12	17,5	50
FJSH15	1/2"	16	21	50
FJSH20	3/4"	21	26	50
FJSH25	1"	26	32	50
FJSH32	1 1/4"	30	44	30
FJSH38	1 1/2"	38	47	30
FJSH51	2"	50,5	59,5	20
FJSH64	2 1/2"	62,9	73,1	15
FJSH75	3"	78	89	15
FJSH100	4"	101,6	114	10



Harici Tip Dişli Metal Rakor (Pano Tipi) / Liquid Tight Connector Straight



PG KOD	DEMR P2	DEMR P3	DEMR P4/P5	DEMR P6	DEMR P7	DEMR P8	DEMR P9	DEMR P10	--	--	
PG Tip Ölçü	Pg 9	Pg 11	Pg 13,5-16	Pg 21	Pg 29	Pg 36	Pg 42	Pg 48	--	--	
Metrik KOD	DEMR M1	DEMR M2	DEMR M3	DEMR M4	DEMR M5	DEMR M6	DEMR M7	DEMR M8	DEMR M9	DEMR M10	DEMR M11
Metrik Tip Ölçü	M12x1,5	M16x1,5	M20x1,5	M25x1,5	M32x1,5	M40x1,5	M50x1,5	M63x1,5	M75x1,5	M80x1,5	M90x1,5
Gas KOD	DEMR G1	DEMR G2	DEMR G3	DEMR G4	DEMR G5	DEMR G6	DEMR G7	DEMR G8	DEMR G9	DEMR G10	DEMR G11
Gas Tip Ölçü	1/4'	3/8'	1/2'	3/4'	1'	1 1/4'	1 1/2'	2'	2 1/2'	3'	4'



Harici Tip Dişli Metal Rakor (Boru Tipi) / Liquid Tight Connector



PG KOD	DEFR P2	DEFR P3	DEFR P4/P5	DEFR P6	DEFR P7	DEFR P8	DEFR P9	DEFR P10	--	--	
PG Tip Ölçü	Pg 9	Pg 11	Pg 13,5-16	Pg 21	Pg 29	Pg 36	Pg 42	Pg 48	--	--	
Metrik KOD	DEFR M1	DEFR M2	DEFR M3	DEFR M4	DEFR M5	DEFR M6	DEFR M7	DEFR M8	DEFR M9	DEFR M10	DEFR M11
Metrik Tip Ölçü	M12x1,5	M16x1,5	M20x1,5	M25x1,5	M32x1,5	M40x1,5	M50x1,5	M63x1,5	M75x1,5	M80x1,5	M90x1,5
Gas KOD	DEFR G1	DEFR G2	DEFR G3	DEFR G4	DEFR G5	DEFR G6	DEFR G7	DEFR G8	DEFR G9	DEFR G10	DEFR G11
Gas Tip Ölçü	1/4'	3/8'	1/2'	3/4'	1'	1 1/4'	1 1/2'	2'	2 1/2'	3'	4'

Harici Tip Döner Dişli Metal Rakor (Pano Tipi) / Swivel External Thread Nickel Plated Brass



PG KOD	DDEMR P2	DDEMR P3	DDEMR P4/P5	DDEMR P6	DDEMR P7	DDEMR P8	DDEMR P9	DDEMR P10	--	--	
PG Tip Ölçü	Pg 9	Pg 11	Pg 13,5-16	Pg 21	Pg 29	Pg 36	Pg 42	Pg 48	--	--	
Metrik KOD	DDEMR M1	DDEMR M2	DDEMR M3	DDEMR M4	DDEMR M5	DDEMR M6	DDEMR M7	DDEMR M8	DDEMR M9	DDEMR M10	DDEMR M11
Metrik Tip Ölçü	M12x1,5	M16x1,5	M20x1,5	M25x1,5	M32x1,5	M40x1,5	M50x1,5	M63x1,5	M75x1,5	M80x1,5	M90x1,5
Gas KOD	DDEMR G1	DDEMR G2	DDEMR G3	DDEMR G4	DDEMR G5	DDEMR G6	DDEMR G7	DDEMR G8	DDEMR G9	DDEMR G10	DDEMR G11
Gas Tip Ölçü	1/4'	3/8'	1/2'	3/4'	1'	1 1/4'	1 1/2'	2'	2 1/2'	3'	4'



ÜRÜN KODU	ÇAP
DE151	1/2"
DE152	3/4"
DE153	1"
DE154	1 1/4"
DE155	1 1/2"
DE156	2"

Vidalı Spiral Rakoru
Straight Squeeze



ÜRÜN KODU	ÇAP
470	3/8"
471	1/2"
472	3/4"
473	1"
474	1 1/4"
475	1 1/2"

Har. Tip Sp. Rakoru Dişli Pano Tipi
Liquid Tight Connector Straight



ÜRÜN KODU	ÇAP
101	1/2"
102	3/4"
103	1"
104	1 1/4"
105	1 1/2"
106	2"

90° Vidalı Spiral Rakoru
90° Straight Squeeze



ÜRÜN KODU	ÇAP
380	1/2"
381	3/4"
382	1"
383	1 1/4"
384	1 1/2"
385	2"

DPN - Spiral Rakoru Dişli Boru Tipi
Liquid Tight Connector



ÜRÜN KODU	ÇAP
DE 180	1/2"
DE 181	3/4"
DE 182	1"

EMT - Sprial Bağlantı Mufu
EMT to Flex



ÜRÜN KODU	ÇAP
390	1/2"
391	3/4"
392	1"
393	1 1/4"
394	1 1/2"
395	2"

DGJ - Spiral Rakor Vidalı Boru Tipi
Liquid Tight Connector



ÜRÜN KODU	ÇAP
DE 461	1/2"
DE 462	3/4"

Spiral - Spiral Ek Mufu
Flex Couplings



ÜRÜN KODU	ÇAP
491	1/2"
492	3/4"
493	1"
494	1 1/4"
495	1 1/2"
496	2"

90° Harici Tip Spiral Rakoru
90° Liquid Tight Connector



ÜRÜN KODU	ÖLÇÜ
DE 451	1/2"
DE 452	3/4"

İçten Vidalı Spiral Rakoru
Screw - In type Connector



ÜRÜN KODU	ÖLÇÜ
471A	1/2"
472A	3/4"
473A	1"
474A	1 1/4"
475A	1 1/2"
476A	2"

Metal Sivama / Inner Core



KABLO RAKORLARI CABLE GLANDS

Polyamid Kablo Rakoru IP68 / Polyamide Cable Glands



Polyamid (PA6) hammadedeli olup, halogen free ve alev özelliklidir. Kablonun dış kılıfını sıkacak özellikte neopren contalıdır. Borusuz olarak döşenen kabloların motor, ekipman vb. bağlantılarında kullanılır.

PG KOD	PKR-P1	PKR-P2	PKR-P3	PKR-P4	PKR-P5	PKR-P6	PKR-P7	PKR-P8	PKR-P9	PKR-P10
PG Tip Ölçü	Pg 7	Pg 9	Pg 11	Pg 13,5	Pg 16	Pg 21	Pg 29	Pg 36	Pg 42	Pg 48
Metrik KOD	PKR-M1	----	PKR-M2	PKR-M3	----	PKR-M4	PKR-M5	PKR-M6	PKR-M7	PKR-M8
Metrik Tip Ölçü	M12x1,5	----	M16x1,5	M20x1,5	----	M25x1,5	M32x1,5	M40x1,5	M50x1,5	M63x1,5
NPT KOD	----	PKR-N2	----	PKR-N3	----	PKR-N4	PKR-N5	----	----	----
NPT Tip Ölçü	----	3/8"	----	1/2"	----	3/4"	1"	----	----	----
Sıkma Aralığı (mm)	3÷6,5	4÷8	5÷10	6÷12	10÷14	13÷18	18÷25	22÷32	30÷38	34÷44

Etanj Tip Metal Kablo Rakoru (Ekonomik Tip) IP68 / Waterproof Cable Glands



Pirinç üzeri nikel kaplamalıdır. Neopren contalı, polyamid (PA6) kliplidir. Contası, -40°C +100°C ısıya dayanıklıdır. Özellikle endüstriyel ortamlardaki pano, motor, vb. bağlantılarında kullanılır.

PG KOD	MKR-P1	MKR-P2	MKR-P3	MKR-P4	MKR-P5	MKR-P6	MKR-P7	MKR-P8	MKR-P9	MKR-P10
PG Tip Ölçü	Pg 7	Pg 9	Pg 11	Pg 13,5	Pg 16	Pg 21	Pg 29	Pg 36	Pg 42	Pg 48
Metrik KOD	MKR-M1	MKR-M2	----	MKR-M3	MKR-M4	MKR-M5	MKR-M6	MKR-M7	----	MKR-M8
Metrik Tip Ölçü	M12x1,5	M16x1,5	----	M20x1,5	M25x1,5	M32x1,5	M40x1,5	M50x1,5	----	M63x1,5
NPT KOD	----	MKR-N1	----	MKR-N2	----	MKR-N3	MKR-N4	MKR-N5	----	----
NPT Tip Ölçü	----	3/8"	----	1/2"	----	3/4"	1"	----	----	----
Sıkma Aralığı (mm)	3÷6,5	4÷8	5÷10	6÷12	10÷14	13÷18	18÷25	22÷32	30÷38	34÷44

Topraklamalı Etanj Tip Metal Kablo Rakoru IP68 / Grounding Cable Glands



Pirinç üzeri nikel kaplamalıdır. Neopren contalı, polyamid (PA6) kliplidir. Contası, -40°C +100°C ısıya dayanıklıdır. Özellikle endüstriyel ortamlardaki zırlı kabloların bağlantılarında kullanılır.

PG KOD	BSEM-01	BSEM-02	BSEM-03	BSEM-04	BSEM-05	BSEM-06	BSEM-07	BSEM-08	BSEM-09	BSEM-10
PG Tip Ölçü	Pg 7	Pg 9	Pg 11	Pg 13,5	Pg 16	Pg 21	Pg 29	Pg 36	Pg 42	Pg 48
Metrik KOD	BMEM-0S	BMEM-01	----	BMEM-02	BMEM-03	BMEM-04	BMEM-05	BMEM-06	----	BMEM-07
Metrik Tip Ölçü	M12x1,5	M16x1,5	----	M20x1,5	M25x1,5	M32x1,5	M40x1,5	M50x1,5	----	M63x1,5
NPT KOD	----	BNEM-E1	----	BNEM-E2	----	BNEM-E3	BNEM-E4	----	----	----
NPT Tip Ölçü	----	3/8"	----	1/2"	----	3/4"	1"	----	----	----
Sıkma Aralığı (mm)	3÷6,5	4÷8	5÷10	6÷12	10÷14	13÷18	18÷25	22÷32	30÷38	34÷44

Etanj Tip Büyük Ölçü Metal Kablo Rakoru (Ekonomik Tip) IP68 / Waterproof Cable Glands



Pirinç üzeri nikel kaplamalıdır. Neopren contalı, polyamid (PA6) kliplidir. Contası, -40°C +100°C ısıya dayanıklıdır. Özellikle büyük kesitli kabloların pano, motor vb. bağlantılarında kullanılır.

Metrik KOD	BDSM-08	BDSM-09S	BDSM-09	BDSM-10	BDSM-10R	BDSM-11	BDSM-11R	BDSM-12	BDSM-13	BDSM-14
Metrik Tip Ölçü	M72x2,0	M75x1,0	M75x2,0	M80x2,0	M80x2,0	M85x2,0	M85x2,0	M90x2,0	M110x2,0	M120x2,0
Sıkma Aralığı (mm)	56÷61	56÷61	56÷61	60÷66	50÷56	68÷76	63÷70	68÷76	75÷82	88÷95

Normal Piriç Kablo Rakoru IP55 / Brass Glands



MS-58 piriç malzemeden imal edilmektedir.
 İstek üzerine nikel kaplamalı da yapılabilir
 Contası, -40°C +100°C ısıya dayanıklıdır.
 Özellikle iç ortamlardaki pano bağlantılarında kullanılır.

PG KOD	NKR-P1	NKR-P2	NKR-P3	NKR-P4	NKR-P5	NKR-P6	NKR-P7	NKR-P8	NKR-P9	NKR-P10
PG Tip Ölçü	Pg 7	Pg 9	Pg 11	Pg 13,5	Pg 16	Pg 21	Pg 29	Pg 36	Pg 42	Pg 48
Sıkma Aralığı (mm)	3÷6	6÷9	6÷10	8÷12	10÷14	14÷19	23÷28	29÷35	35÷41	39÷45
Delik Çapı (mm)	12,5	15,5	18,5	20,5	22,5	28,5	37,5	47	55	60
Metrik KOD	NKR-M1	NKR-M2	NKR-M3	NKR-M4	NKR-M5	NKR-M6	NKR-M7	NKR-M8	NKR-M9	NKR-M10
Metrik Tip Ölçü	M12x1,5	M16x1,5	M20x1,5	M25x1,5	M32x1,5	M40x1,5	M50x1,5	M63x1,5	M75x1,5	M90x1,5
Sıkma Aralığı (mm)	3÷6,5	6÷9	8÷12	14÷19	18÷24	29÷35	35÷41	43÷49	55÷62	64÷72
Delik Çapı (mm)	12	16	20	25	32	40	50	63	75	90

Kelepçeli Piriç Kablo Rakoru IP55/ Compression Glands



MS-58 piriç malzemeden imal edilmektedir.
 İstek üzerine nikel kaplamalı da yapılabilir
 Contası, -40°C +100°C ısıya dayanıklıdır.
 Özellikle yer altı kablolarının pano bağlantılarında kullanılır.

PG KOD	KKR-P1	KKR-P2	KKR-P3	KKR-P4	KKR-P5	KKR-P6	KKR-P7	KKR-P8	KKR-P9	KKR-P10
PG Tip Ölçü	Pg 7	Pg 9	Pg 11	Pg 13,5	Pg 16	Pg 21	Pg 29	Pg 36	Pg 42	Pg 48
Sıkma Aralığı (mm)	3÷6	6÷9	6÷10	8÷12	10÷14	14÷19	23÷28	29÷35	35÷41	39÷45
Delik Çapı (mm)	12,5	15,5	18,5	20,5	22,5	28,5	37,5	47	55	60
Metrik KOD	KKR-M1	KKR-M2	KKR-M3	KKR-M4	KKR-M5	KKR-M6	KKR-M7	KKR-M8	KKR-M9	KKR-M10
Metrik Tip Ölçü	M12x1,5	M16x1,5	M20x1,5	M25x1,5	M32x1,5	M40x1,5	M50x1,5	M63x1,5	M75x1,5	M90x1,5
Sıkma Aralığı (mm)	3÷6,5	6÷9	8÷12	14÷19	18÷24	29÷35	35÷41	43÷49	55÷62	64÷72
Delik Çapı (mm)	12	16	20	25	32	40	50	63	75	90

Özel Ölçü Piriç Kablo Rakoru IP55/ Special Size Brass Glands



MS-58 piriç malzemeden imal edilmektedir.
 İstek üzerine nikel kaplamalı da yapılabilir
 Contası, -40°C +100°C ısıya dayanıklıdır.
 Özellikle yer altı kablolarının pano bağlantılarında kullanılır.

Normal Tip Kod	NKR-Ø25	NKR-Ø55	NKR-Ø60	NKR-Ø70	NKR-Ø80	NKR-Ø90	NKR-Ø100	NKR-Ø125	NKR-Ø150	NKR-M100
Kelepçeli Tip Kod	KKR-Ø25	KKR-Ø55	KKR-Ø60	KKR-Ø70	KKR-Ø80	KKR-Ø90	KKR-Ø100	KKR-Ø125	KKR-Ø150	---
Ölçü	Ø25	Ø55	Ø60	Ø70	Ø80	Ø90	Ø100	Ø125	Ø150	Ø100
Sıkma Aralığı (mm)	19÷24	43÷49	47÷54	55÷62	64÷72	74÷82	85÷92	92÷110	115÷135	74÷82
Delik Çapı (mm)	32	65	70	80	90	100	110	135	160	100



Materyal: Polyamid & piriç. / Polyamide & brass.
 Kullanım Alanı: Boş deliklerin kapatılması için kullanılır.

Kör Tapa / Plug



METAL KÖR TAPA		POLYAMİD KÖR TAPA	
Metrik Kod	PG Kod	Metrik Kod	PG Kod
MKT-M16	MKT-PG7	PKT-M16	PKT-PG7
MKT-M20	MKT-PG9	PKT-M20	PKT-PG9
MKT-M25	MKT-PG11	PKT-M25	PKT-PG11
MKT-M32	MKT-PG13	PKT-M32	PKT-PG13
MKT-M40	MKT-PG16	PKT-M40	PKT-PG16
MKT-M50	MKT-PG21	PKT-M50	PKT-PG21
MKT-M63	MKT-PG29	PKT-M63	PKT-PG29
MKT-M75	MKT-PG36	PKT-M75	PKT-PG36
	MKT-PG42		PKT-PG42

KABLO KELEPÇESİ CABLE CLEATS

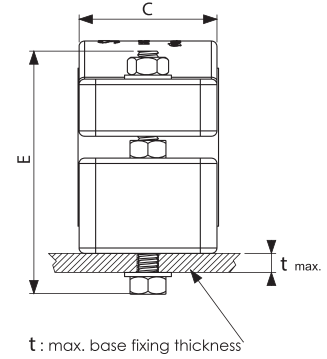
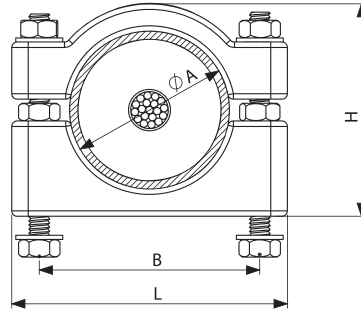

* Contact us for other sizes. Please specify the size of outer diameter of the cable.

Poly. Kablo Kelepçesi(Tekli)
Poly. Cable Cleat (Single)



PCC

Catalog N.	Cable Outer Dia. ØA (mm)		DIMENSIONS (mm)					E (Bolts)	
	min.	max.	B	C	L	H max.	t	Size	Torque
PCC-34	26	34	50	35	65	56	20	M6x80	5 Nm
PCC-42	35	42	55	40	76	60	12	M6x80	5 Nm
PCC-50	44	50	70	45	90	70	20	M8x90	6 Nm
PCC-58	52	58	80	50	100	78	12	M8x90	6 Nm

Operating temperature : -40 °C / +120 °C
Resistance to impact : Very Heavy (20 0J)
Resistance to UV : Resistive

Flame propagation : Resistive
Material : Polyamide Mixture
Standard : EN 61914'

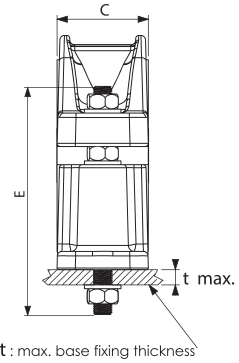
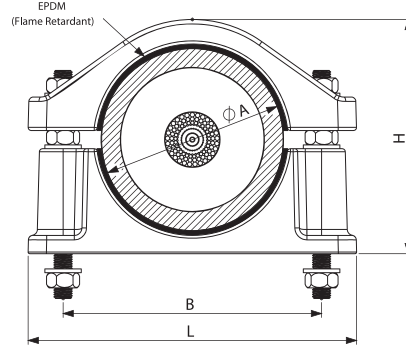
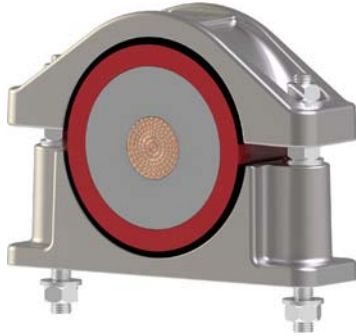

* Contact us for other sizes. Please specify the size of outer diameter of the cable.

Alüminyum Kablo Kelepçesi(Tekli)
Aluminum Cable Cleat (Single)



ACC

Catalog N.	Cable Outer Dia. ØA (mm)		DIMENSIONS (mm)					E (Bolts)	
	min.	max.	B	C	L	H max.	t	Size	Torque
ACC-40	31	40	66	45	90	68	10	M8	20Nm
ACC-50	41	50	76	45	100	73			
ACC-60	51	60	100	60	134	82	10	M12	25 Nm
ACC-70	61	70	110	60	144	94			
ACC-80	71	80	120	60	154	106			
ACC-90	81	90	130	60	164	118			
ACC-100	91	100	140	60	174	130			
ACC-110	101	110	160	60	206	141			
ACC-120	111	120	170	60	216	154			
ACC-130	121	130	180	70	226	167			

Operating temperature : -40 °C / +120 °C
Resistance to impact : Very Heavy (20 0J)
Material : Aluminum Casting
Standard : EN 61914'

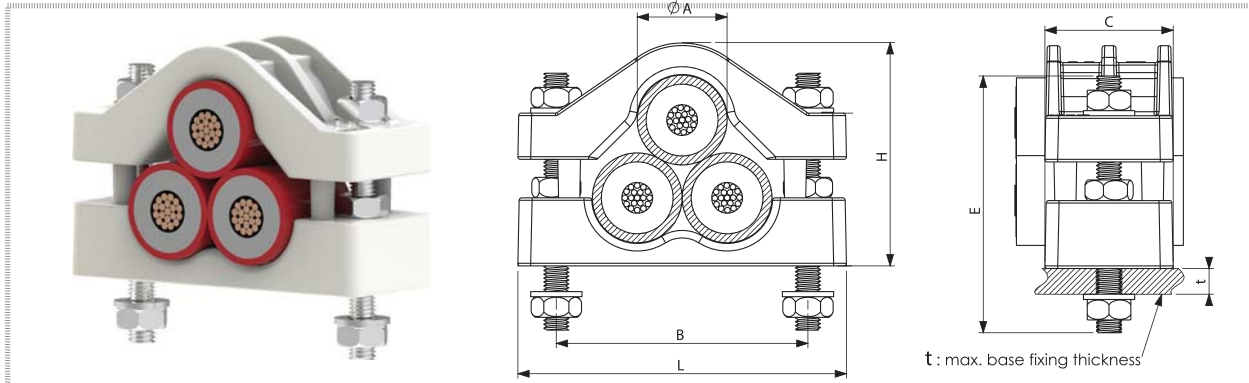

* Contact us for other sizes. Please specify the size of outer diameter of the cable.

Poly. Kablo Kelepçesi (Yonca Form)
 Poly. Cable Cleat (Trefoil)

PCCT

Catalog N.	Cable Outer Dia. ØA (mm)		DIMENSIONS (mm)					E (Bolts)	
	min.	max.	B	C	L	H max.	t	Size	Torque
PCCT-21	15	21	68	50	98	59	20	M10x100	10 Nm
PCCT-28	22	28	82	50	112	71	15	M10x100	10 Nm
PCCT-35	29	35	98	50	128	87	10	M10x100	

Operating temperature : -40 °C / +120 °C
 Resistance to impact : Very Heavy (20 0J)
 Resistance to UV : Resistive

Flame propagation : Resistive
 Material : Polyamide Mixture
 Standard : EN 61914'

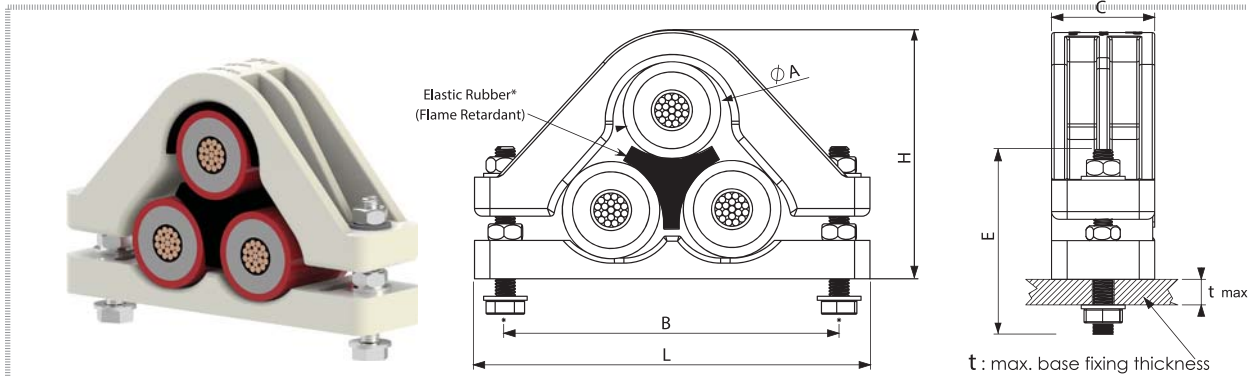

* Contact us for other sizes. Please specify the size of outer diameter of the cable.

Poly. Kablo Kelepçesi (Yonca Form)
 Poly. Cable Cleat (Trefoil)

PCCT 46

Catalog N.	Cable Outer Dia. 3 x ØA (mm)		DIMENSIONS (mm)					E (Bolts)	
	min.	max.	B	C	L	H max.	t	Size	Torque
PCCT-46-1*	36	37	130	40	154	94	20	M8x70	10 Nm
PCCT-46-2*	38	39				97	20		
PCCT-46-3*	40	41				101	20		
PCCT-46-4*	42	43				103	10		
PCCT-46-5						102	10		
PCCT-46-6	45	46				107	10		

With Elastic Rubber

Operating temperature : -40 °C / +120 °C
 Resistance to impact : Very Heavy (20 0J)
 Resistance to UV : Resistive

Flame propagation : Resistive
 Material : Polyamide Mixture
 Standard : EN 61914'

KABLO KELEPÇESİ CABLE CLEATS

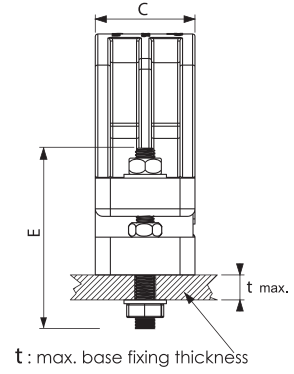
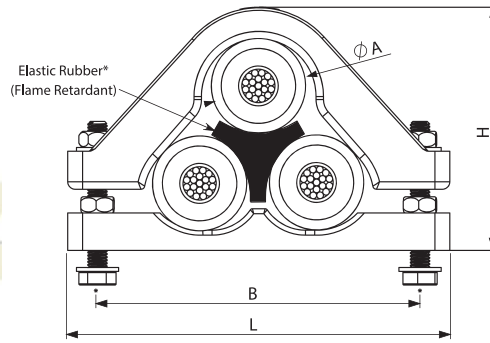

* Contact us for other sizes. Please specify the size of outer diameter of the cable.

Poly. Kablo Kelepçesi (Yonca Form)
Poly. Cable Cleat (Trefoil)



PCCT-58

Catalog N.	Cable Outer Dia. 3 x ØA (mm)		DIMENSIONS (mm)					E (Bolts)	
	min.	max.	B	C	L	H max.	t	Size	Torque
PCCT-58-1*	47	48	162	50	192	118	20	M10x80	10 Nm
PCCT-58-2*	49	50				125	10		
PCCT-58-3*	51	52				128	10		
PCCT-58-4*	53	54				134	10		
PCCT-58-5*						136	10	M10x90	
PCCT-58-6						132	10		
PCCT-58-7						133	10		
PCCT-58-8						135	10		

Operating temperature : -40 °C / +120 °C
Resistance to impact : Very Heavy (20 0J)
Resistance to UV : Resistive

Flame propagation : Resistive
Material : Polyamide Mixture
Standard : EN 61914'

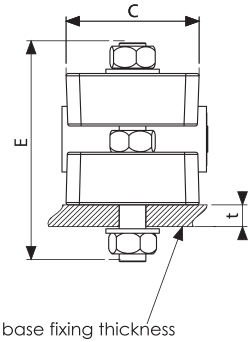
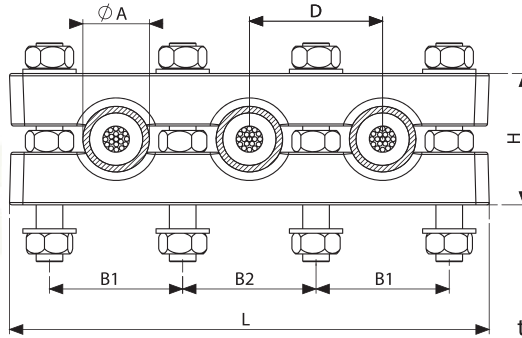

* Contact us for other sizes. Please specify the size of outer diameter of the cable.

Poly. Kablo Kelepçesi - Düzlem form. (Üç Kablolu)
Poly. Cable Cleat - Flat form. (Three Cables)



PCC-3FF

Catalog N.	CABLE Outer Dia. 3 x ØA (mm)		DIMENSIONS (mm)							E (Bolts)	
	min.	max.	B1	B2	C	D	L	H max.	t	Size	Torque
PCC-3FF30	21	30	60	60	60	60	216	60	10	M12x100	10 Nm
PCC-3FF40	31	40	76	80		80	268	80	10	M12x120	
PCC-3FF50	41	50	91	100		100	318	100	10	M12x140	

Operating temperature : -40 °C / +120 °C
Resistance to impact : Very Heavy (20 0J)
Resistance to UV : Resistive

Flame propagation : Resistive
Material : Polyamide Mixture
Standard : EN 61914'



www.deltafleks.com
info@deltafleks.com



Atkore™

FLEXICON

FLEXIBLE CONDUIT SOLUTIONS



SPIRAL BORU & RAKORLARI
product & solutions guide
THE POWER IN CABLE MANAGEMENT



METAL SİRİRAL BORULAR
METALLIC CONDUITS

KULLANIM ALANLARI
TYPICAL APPLICATIONS

TYPE FU
Galvaniz Çelik
Galvanized Steel



Binalarda asma tavan, alçıpan bölme, döşeme altı sistemleri ve ofis uygulamalarında kullanılır.

TYPE SSU
Paslanmaz Çelik
Stainless Steel



Gıda ve kimya sektöründe, enstrüman bağlantılarında ve güvenlik sistemlerinde kullanılır.

TYPE FSU
PVC Kaplı Çelik
Steel PVC Coated



Tüm sanayi tesislerinde, inşaat sektöründe, makina, elektrik, elektronik ve enstrüman sistemlerinin bağlantı ve montajlarında kullanılır.

TYPE FNU
Termoplastik Kaplı Çelik
Termoplastic Coated



Hassas uygulamalarda, yüksek sıcaklıkta, yağlı ve darbeli ortamlarda, elektrik sistemlerinin korumasında kullanılır.

TYPE LFHU
LFH Kaplı Çelik
LFH Coated



İş merkezleri, kamu binaları, hastaneler ve tünellerde, elektrik ve aydınlatma sistemlerinin korumasında kullanılır.

TYPE FSB
PVC Galvaniz Çelik Örgülü
PVC Steel Braid



Endüstriyel tesislerde, ısı ve darbeye maruz alanlarda ve manyetik gürültüye açık yerlerde kullanılır.

TYPE FB
Galvaniz Çelik Örgülü
Steel Braid



Endüstriyel tesislerde, ısı ve darbeye maruz alanlarda ve manyetik gürültüye açık yerlerde kullanılır.

TYPE FPRSS
SS316 Kaplı Polyamid
PA6-SS316 corrugated



Metroda, trenlerde ve terminallerinde darbelere, ısıya, vibrasyona ve manyetik gürültüye maruz kalan yerlerde kullanılır.

TYPE LTP
PVC Kaplı Harici Tip
Liquid Tight



Harici tip ortamlarda, güneş, su, sıcaklık ve toza karşı koruma gerektiren alanlarda, elektrik kablo ve cihazların korumasında kullanılır.

TYPE LTPHC
Termoplastik Lastik Kaplı
Liquid Tight



Harici tip ortamlarda, don, yüksek ısı, su ve toza karşı koruma gerektiren alanlarda, elektrik kablo ve cihazların korumasında kullanılır.

TYPE LTPUL
PVC Kaplı Harici Tip
Liquid Tight









































Harici tip ortamlarda güneş, su, sıcaklık ve toza karşı koruma gerektiren alanlarda, elektrik kablo ve cihazların korumasında kullanılır.

TYPE FPIHSS
SS316 Örgülü Polyamid
Nylon with SS Overbraid



Metrolarda, trenlerde ve terminallerinde her türlü darbelerle karşı koruma gerektiren alanlarda kullanılır.

Koruma Sınıfı IP Rating Available	Isı Aralığı Temperature Range	Çekme Kuvveti Pull of Strength	Baskı Dayanımı Comp. Str.	Aleve Dayanım Low Fire Haz.	Halogenfree	Isıyla Büzüşme Self Ext.	EMC Screening	Demiryolu Araçları Rolling Stock	UV Dayanımı UV Res. Black
IP 40	-50° C to 300° C	120	350						
IP 40	-50° C to 300° C	170	400						
IP 54 IP 65	-15° C to 70° C	120	350						
IP 54 IP 65	-40° C to 120° C	120	350						
IP 54 IP 65	-25° C to 90° C	120	350						
IP 54	-15° C to 70° C	120	350						
IP 40	-50° C to 300° C	120	350						
IP 67	-40° C to 120° C	100	75						
IP 66 IP 67 IP 68	-20° C to 105° C	130	400						
IP 66 IP 67 IP 68	-45° C to 135° C	130	400						
IP 66 IP 67 IP 68	-15° C to 75° C	160	500						
IP 66 IP 67	-15° C to 70° C	50	400						



ÜRÜN KODU STEEL	ÜRÜN KODU SS316	İÇ ÇAP (mm)	DIŞ ÇAP (mm)	MİN. BÜKÜLME ÖLÇÜSÜ (mm)	RULO UZUNLUĞU (mt)
FU10	SSU10	6.8	9	25	50
FU12	SSU12	10.2	13	30	50
FU16	SSU16	13	16	40	50
FU20	SSU20	16.9	20.5	45	50
FU25	SSU25	21.1	25	55	50
FU32	SSU32	28.1	32	70	25
FU40	SSU40	37.6	42.5	80	25
FU50	SSU50	48.4	53	90	25
FU63	SSU63	57.5	62.5	115	10

FU Galvaniz Kaplı Çelik / Galvanized Steel
SSU Paslanmaz Çelik / Stainless Steel



Koruma Sınıfı: IP 40 / Protection IP: IP40

Çalışma Sıcaklığı - Çelik Spiral / Temperature Range: -100° C - +300° C

Çalışma Sıcaklığı - SS316 Spiral / Temperature Range: -100° C - +400° C



ÜRÜN KODU	İÇ ÇAP (mm)	DIŞ ÇAP (mm)	MİN. BÜKÜLME ÖLÇÜSÜ (mm)	RULO UZUNLUĞU (mt)
FSU10	6.8	10	25	50
FSU12	10.2	14	30	50
FSU16	13	17	40	50
FSU20	16.9	21.5	45	50
FSU25	21.1	26	55	50
FSU32	28.1	34	70	25
FSU40	37.6	44.5	80	25
FSU50	48.4	55	90	25
FSU63	57.5	64.5	115	10
FSU75	70	79	150	10

FSU-PVC Kaplı Çelik Spiral Boru
Galvanized Steel PVC Coated



Koruma Sınıfı: IP54, IP65 / Protection IP: IP54, IP65

Çalışma Sıcaklığı / Temperature Range: -15° C - +70° C

UV Resistant (UL Report No: 13CA50836)

Alev Yayılmaz / Self Extinguishing EN 61386-1

(BSI Report No: 2381/7847798)



ÜRÜN KODU	İÇ ÇAP (mm)	DIŞ ÇAP (mm)	MİN. BÜKÜLME ÖLÇÜSÜ (mm)	RULO UZUNLUĞU (mt)
	6.8	10	25	50
LFHU12	10.2	14	30	50
LFHU16	13	17	40	50
LFHU20	16.9	21.5	45	50
LFHU25	21.1	26	55	50
LFHU32	28.1	34	70	25
LFHU40	37.6	44.5	80	25
LFHU50	48.4	55	90	25
LFHU63	57.5	64.5	115	10
LFHU75	70	79	150	10

LFHU-LFH Kaplı Çelik Spiral Boru
Steel LFH Coated



Koruma Sınıfı: IP54, IP65 / Protection IP: IP54, IP65

Çalışma Sıcaklığı / Temperature Range: -25° C - +90° C

Halogen, sulphur and phosphorus free

Yangına karşı ekstra koruma UL94 V0 / Extra low fire hazard UL94 V0

Compliant to LUL Std 1-085

Vibration & shock tested to EN61373 Cat 2



FB Çelik Örgülü Çelik Spiral Boru
Galvanised Steel Braided



ÜRÜN KODU	İÇ ÇAP mm	DIŞ ÇAP mm	MİN. BÜKÜLME ÖLÇÜSÜ mm	RULO UZUNLUĞU mt
FB12	10.2	14	30	25
FB16	13	17.5	40	25
FB20	16.9	21.5	45	25
FB25	21.1	26	55	25
FB32	28.1	34	70	25
FB40	37.6	26.5	80	10

Yüksek sıcaklığa maruz yerlerde kullanılır. / Industrial environments and high temperatures

Koruma Sınıfı / IP Rating: IP40

Çalışma Sıcaklığı / Temperature Range: -100° C - +300° C

Yüksek darbe dayanımı / Provides high tensile strength and resistance to abrasion, corrosion and vandals

Provides EMC Screening 55dB@1MHz



M-Sabit Dişli Pirinç Rakor
Straight External Thread Nickel
Plated Brass



ÖLÇÜ (metrik)	ÜRÜN KODU	ÖLÇÜ (PG)	ÜRÜN KODU
M12	FSU10-M12-M	PG7	FSU10-PG7-M
M16	FSU12-M16-M	PG9	FSU12-PG9-M
M16	FSU16-M16-M	PG11	FSU16-PG11-M
M20	FSU16-M20-M		
M20	FSU20-M20-M	PG16	FSU20-PG16-M
M25	FSU25-M25-M	PG21	FSU25-PG21-M
M32	FSU32-M32-M	PG29	FSU32-PG29-M
M40	FSU40-M40-M	PG36	FSU40-PG36-M
M50	FSU50-M50-M	PG42	FSU50-PG48-M
M63	FSU63-M63-M		
M75	FSU75-M75-M		



S-Döner Dişli Pirinç Rakor
Swivel External Thread Nickel
Plated Brass



ÖLÇÜ (metrik)	ÜRÜN KODU	ÖLÇÜ (PG)	ÜRÜN KODU
M12	FSU10-M12-S	PG7	FSU10-PG7-S
M16	FSU12-M16-S	PG9	FSU12-PG9-S
M16	FSU16-M16-S	PG11	FSU16-PG11-S
M20	FSU16-M20-S		FSU16-PG13-S
M20	FSU20-M20-S	PG16	FSU20-PG16-S
M25	FSU25-M25-S	PG21	FSU25-PG21-S
M32	FSU32-M32-S	PG29	FSU32-PG29-S
M40	FSU40-M40-S	PG36	FSU40-PG36-S
M50	FSU50-M50-S	PG42	FSU50-PG42-S
M63	FSU63-M63-S		



P-Sonlama Rakoru & Tip FCC Klips
Plain Hole Connector & Steel P Clip



DELİK ÖLÇÜSÜ	P TİPİ RAKOR ÜRÜN KODU	ÖLÇÜ	KLİPS ÜRÜN KODU
9	FSU10-P	10	FCC10
12	FSU12-P	12	FCC12
16	FSU16-P	16	FCC16
20	FSU20-P	20	FCC20
25	FSU25-P	25	FCC25
32	FSU32-P	32	FCC32
40	FSU40-P	40	FCC40



ÖLÇÜ (metrik)	ÜRÜN KODU	ÖLÇÜ PG	ÜRÜN KODU
M16	FSU12-M16-C	9	FSU12-PG9-C
M16	FSU16-M16-C	11	FSU16-PG11C
M20	FSU20-M20-C	16	FSU20-PG16-C
M25	FSU25-M25-C	21	FSU25-PG21-C
M32	FSU32-M32-C	29	FSU32-PG29-C
M40	FSU40-M40-C	36	FSU40-PG42-C

C-IP65 Rakor / IP65 Fittings



ÖLÇÜ metrik	ÜRÜN KODU	ÖLÇÜ PG	ÜRÜN KODU
M16	FSU16-M16-C90	11	FSU11-PG16-C90
M20	FSU20-M20-C90	16	FSU20-PG16-C90
M25	FSU25-M25-C90	21	FSU25-PG21-C90
M32	FSU32-M32-C90	29	FSU32-PG29-C90
M40	FSU40-M40-C90	36	FSU40-PG42-C90

C-IP65 90° Dirsek
IP65 Elbow



ÖLÇÜ metrik	ÜRÜN KODU	ÖLÇÜ PG	ÜRÜN KODU
M16	BM90-16M	PG7	BM90-PG7
M20	BM90-20M		
M25	BM90-25M		
M32	BM90-32M		
M40	BM90-40M		
M50	BM90-50M		

90° Dirsek / 90° Elbow



ÖLÇÜ metrik	ÜRÜN KODU	ÖLÇÜ PG	ÜRÜN KODU
M12	B-M12	PG9	B-PG9
M16	B-M16	PG11	B-PG11
M20	B-M20	PG13	B-PG13
M25	B-M25	PG16	B-PG16
M32	B-M32	PG21	B-PG21
M40	S-M40	PG29	B-PG29
M50	S-M50	PG36	B-PG36
M63	S-M63	PG42	B-PG42
M75	S-M75	PG48	B-PG48

B Piriç Somun / Locknuts





LTP-Harici Tip Spiral Boru
PVC Coated Liquid Tight



ÜRÜN KODU	İÇ ÇAP (mm)	DIŞ ÇAP (mm)	MİN. BÜKÜLME ÖLÇÜSÜ (mm)	RULO UZUNLUĞU (mt)
LTP10	7	11.8	35	50
LTP12	10	14.2	40	50
LTP16	12.6	17.8	45	50
LTP20	16	21.1	65	50
LTP25	21	26.4	100	50
LTP32	26.5	33.1	135	25
LTP40	35.4	41.8	175	25
LTP50	40.4	47.9	230	25
LTP63	51.6	59.7	290	10

UV Koruma / UV Resistant

Koruma Sınıfı / IP Rating: IP66, IP67, IP68, IP69K

Çalışma Sıcaklığı / Temperature Range: -20° C - +105° C

Vibration & shock tested to EN61373 Cat 2

LTP has Lloyd's Register type approval

Düz temiz yüzey / Smooth wipe clean outer cover

Isiya ve yağlara karşı koruma / Oil resistant and high temperature pvc cover



C Harici Tip Rakor IP68
External Thread Nickel Plated Brass



ÖLÇÜ (metrik)	ÜRÜN KODU	ÖLÇÜ PG	ÜRÜN KODU
M12	LTP10-M12-C	PG7	LTP10-PG7-C
M16	LTP12-M16-C	PG9	LTP12-PG9-C
M16	LTP16-M16-C	PG11	LTP16-PG11-C
M20	LTP16-M20-C	PG13	LTP16-PG13-C
M20	LTP20-M20-C	PG16	LTP20-PG16-C
M25	LTP25-M25-C	PG21	LTP25-PG21-C
M32	LTP32-M32-C	PG29	LTP32-PG29-C
M40	LTP40-M40-C	PG36	LTP40-PG 36-C
M50	LTP50-M50-C	PG42	LTP50-PG42-C
M63	LTP63-M63-C	PG48	LTP50-PG48



C90 Harici Tip 90° Rakor IP68
External Thread Elbow



ÖLÇÜ (metrik)	ÜRÜN KODU	ÖLÇÜ PG	ÜRÜN KODU
M16	LTP12--M16-C90	PG9	LTP12-PG9-C90
M16	LTP16-M16-C90	PG11	LTP16-PG11-C90
M29	LTP16-M20-C90	PG13	LTP16-PG13-C90
M20	LTP20-M20-C90	PG16	LTP20-PG16-C90
M25	LTP25-M25-C90	PG21	LTP25-PG21-C90
M32	LTP32-M32-C90	PG29	LTP32-PG29-C90
M40	LTP40-M40-C90	PG36	LTP40-PG36-C90
M50	LTP50-M50-C90	PG42	LTP50-PG42-C90
M63	LTP63-M63-C90	PG48	LTP50-PG48-C90

PVC ve POLYAMİD SİRAL BORULAR
NON METALLIC CONDUITS

KULLANIM ALANLARI
TYPICAL APPLICATIONS

TYPE FPAS
Nylon LFH PA6 Spiral
Std. Weight



Tüm inşaat, sanayi, makina otomotiv, gemi, yat, tren, robot, ısıtma ve soğutma sistemleri, güvenlik sistemlerinde iç ve dış ortamlarda kablo koruyucu olarak kullanılır.

TYPE FPAL
Nylon PA6 Spiral
Light Weight

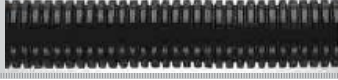

Tüm inşaat, sanayi, makina otomotiv, gemi, yat, tren, robot, ısıtma ve soğutma sistemleri, güvenlik sistemlerinde kablo koruyucu olarak kullanılır.

TYPE FPR
Nylon Extra LFH PA6
Std. Weight



Demiryolları, metro ve tünellerde, tren, gemi, yat sanayinde ve inşaat sektöründeki tüm yapılarda iç ve dış ortamlarda koruyucu olarak kullanılır.

TYPE FPAH
Nylon Extra LFH PA6
Heavy Weight



Tüm inşaat, sanayi, makina otomotiv, gemi, yat, tren, robot, ısıtma ve soğutma sistemleri, güvenlik sistemlerinde iç ve dış ortamlarda yüksek dayanımlı kablo koruyucu olarak kullanılır.

TYPE FPI
Nylon PA12 Spiral
Std. Weight



Robot sistemlerinde ve sürekli hareket gerektiren alanlarda, aşırı soğuk ve sıcak ortamlarda kablo koruyucu olarak kullanılır.

TYPE FPIH
Nylon PA12 Spiral
Heavy Weight



Robot sistemlerinde ve sürekli hareket gerektiren alanlarda, aşırı soğuk ve sıcak ortamlarda yüksek dayanımlı kablo koruyucu olarak kullanılır.

TYPE FPY
Nylon PA6 Spiral
Light Weight



Makina montajında ve otomotiv sektöründe, özellikle dorseler, temizlik araçları ve diğer iş makinalarında yüksek dayanımlı kablo koruyucu olarak kullanılır.

TYPE FPP
Polypropylene Spiral
Std. Weight

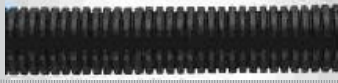

Kimya sektöründe asitli ortamlarda ve inşaat sektöründe siva altı tesisatlarda kullanılır.

TYPE FPY
Nylon PA6 Battal Boy
Large Diameter



Makina, gemi ve yat sektöründe solvent ve yağlara karşı dayanımlı çoklu kabloların montajında koruyucu olarak kullanılır.

TYPE FPL
UPVC Spiral
UPVC Corrugated



İnşaat sektöründe tüm bina içi ve bina dışı uygulamalarda kullanılır.

TYPE FPCB
PVC Takviyeli Spiral
PVC Spiral Reinforced





































Her türlü makina montajı ve bina içi elektrik sistemlerinin bağlantılarında kablo koruyucu olarak kullanılır.

TYPE LPC
Düz PVC Spiral
Smooth PVC Spiral



Gıda ve makina sektöründe, ıslak ve yağlı zeminlerde, su, toz, kir tutması sakıncalı alanlarda, kablo ve cihazların korumasında kullanılır.

Koruma Sınıfı IP Rating Available	Isı Aralığı Temperature Range	Çekme Kuvveti Pull of Strength	Baskı Dayanımı Comp. Str.	Aleve Dayanım Low Fire Haz.	Halogenfree	Isıyla Büzüşme Self Ext.	EMC Screening	Demiryolu Araçları Rolling Stock	UV Dayanımı UV Res. Black
IP 66 IP 67 IP 68	-40° C to 120° C	40	75						
IP 66 IP 67 IP 68	-40° C to 120° C	30	60						
IP 66 IP 67 IP 68	-40° C to 120° C	40	75						
IP 66 IP 67 IP 68	-40° C to 120° C	70	120						
IP 66 IP 67 IP 68	-50° C to 110° C	30	45						
IP 66 IP 67 IP 68	-50° C to 110° C	50	60						
IP 40 IP 66 IP 67 IP 68	-40° C to 120° C	25	60						
IP 40 IP 66 IP 67 IP 68	-20° C to 90° C	25	35						
IP 40 IP 65	-40° C to 120° C								
IP 40 IP 66 IP 67 IP 68	-5° C to 70° C	30	150						
IP 65	-5° C to 70° C	25	60						
IP 67	--5° C to 70° C	50	120						



FPAL Polyamid Spiral Boru (PA6)
Polyamid Halogenfree Conduit



Alev yaymaz / *Self extinguishing*
Halogen, sulphur and phosphorus free
UL recognized

Koruma / *Protection*: IP 66, IP67, IP68, IP69K

Çalışma Sıcaklığı / *Temperature Range*: -40° C - 120° C

Solvent ve yağlara karşı yüksek dayanım / *Highly resistant to solvents and oils*

ÜRÜN KODU	İÇ ÇAP mm	DIŞ ÇAP mm	MİN. BÜKÜLME ÖLÇÜSÜ mm	RULO UZUNLUĞU mt
FPY06	5	7.3	10	100
FPAL10	6.5	10	15	50
FPAL11	8,4	11,5	20	50
FPAL13	10	13	25	50
FPAL16	12	15.8	35	50
FPAL18	14.2	18.5	35	50
FPAL21	16.9	21.2	40	50
FPAL28	23	28.5	45	50
FPAL34	28.3	34.5	55	25
FPAL42	35.7	42.5	65	25
FPAL54	47.4	54.5	80	25
FPAL67	56,5	67,2	110	10



FPAS Polyamid Spiral Boru (PA6)
Polyamid Halogenfree Conduit



Koruma / *Protection*: IP 66, IP67, IP68, IP69K
Halogen, sulphur and phosphorus free

Çalışma Sıcaklığı / *Temperature Range*: -40° C - 120° C

Solvent ve yağlara karşı yüksek dayanım / *Highly resistant to solvents and oils*

UL listed / *UL recognized*

Lloyd's register type approval

Yangına karşı ekstra koruma UL94 V2 / *Extra low fire hazard UL94 V2 flame retardancy*

UV Resistant

Aşınmalara karşı yüksek dayanım / *Abrasion resistant*

ÜRÜN KODU	İÇ ÇAP mm	DIŞ ÇAP mm	MİN. BÜKÜLME ÖLÇÜSÜ mm	RULO UZUNLUĞU mt
FPAS10	6.3	10	15	50
FPAS11	8,2	11,5	20	50
FPAS13	9.8	13	25	50
FPAS16	11.8	25.8	40	50
FPAS18	14,2	18,5	40	50
FPAS21	16.7	21.2	45	50
FPAS28	22.8	28.5	50	50
FPAS34	28.1	34.5	60	25
FPAS42	35.5	42.5	70	25
FPAS54	47.2	54.5	80	25
FPAS67	56,3	67,2	130	10



Halogen, sulphur and phosphorus free
UL recognized / *UV Resistant*

Alev yaymaz / *Self extinguishing and low fire hazard*

Koruma Sınıfı / *Protection Rating*: IP 66, IP67, IP68, IP69K

Çalışma Sıcaklığı / *Temperature Range*: -50° C - +110° C

FPI Polyamid Spiral Boru (PA12)
Polyamid Halogenfree Conduit



ÜRÜN KODU	İÇ ÇAP mm	DIŞ ÇAP mm	MİN. BÜKÜLME ÖLÇÜSÜ mm	RULO UZUNLUĞU mt
FPI13	9,8	13	25	50
FPI16	11,8	15,8	30	50
FPI21	16,7	21,2	35	50
FPI28	21,7	28,5	45	50
FPI34	28,1	34,5	55	25
FPI42	35,5	42,5	60	25
FPI54	47,2	54,5	70	25
FPI67	56,3	67,2	120	10

 FPA Polyamid Rakor IP66 - IP67
 Straight External Thread

ÖLÇÜ metrik	ÜRÜN KODU	ÖLÇÜ PG	ÜRÜN KODU	ÖLÇÜ inch	ÜRÜN KODU
M12	FPA10-M12	PG7	FPA10-PG7		
M12	FPA11-M12	PG7	FPA11-PG7		
M16	FPA13-M16	PG9	FPA10-PG9		
M16	FPA16-M16	PG9	FPA13-PG9	1/2"	FPA16-050
M20	FPA13-M20	PG9	FPA16-PG9	1/2"	FPA21-050
M20	FPA16-M20	PG11	FPA13-PG11	3/4"	FPA28-075
M20	FPA18-M20	PG11	FPA16-PG11	1"	FPA34-100
M20	FPA21-M20	PG13	FPA13-PG13	1-1/4"	FPA42-125
M25	FPA16-M25	PG13	FPA16-PG13	1-1/2"	FPA42-150
M25	FPA21-M25	PG13	FPA18-PG13	1-1/2"	FPA54-150
M25	FPA28-M25	PG13	FPA21-PG13	2"	FPA54-200
M32	FPA34-M32	PG16	FPA16-PG16		
M40	FPA42-M40	PG16	FPA21-PG16		
M50	FPA42-M50	PG16	FPA28-PG16		
M50	FPA54-M50	PG21	FPA21-PG21		

 Polyamid 90° Dirsek
 90° Elbow

ÖLÇÜ metrik	ÜRÜN KODU	ÖLÇÜ PG	ÜRÜN KODU	ÜRÜN KODU (inch)
M12	FPA10-M12-90	PG7	FPA10-PG7-90	
M16	FPA13-M16-90	PG9	FPA13-PG9-90	
M16	FPA16-M16-90	PG9	FPA16-PG9-90	FPA16-050-90-1/2"
M20	FPA16-M20-90	PG11	FPA16-PG11-90	FPA21-050-90-1/2
M20	FPA21-M20-90	PG13	FPA16-PG13-90	FPA28-075-90-3/4
M25	FPA28-M25-90	PG13	FPA21-PG13-90	FPA34-100-90-1
M32	FPA34-M32-90	PG16	FPA21-PG16-90	FPA42-125-90-1 1/4
M40	FPA42-M40-90	PG21	FPA28-PG21-90	FPA42-150-90-1 1/2
M50	FPA42-M50-90	PG29	FPA34-PG29-90	FPA54-150-90-1 1/2
M50	FPA54-M50-90	PG36	FPA42-PG36-90	FPA54-200-90-2

 MPS Polyamid Rakor IP67, IP68
 Polyamid Fittings

ÖLÇÜ metrik	ÜRÜN KODU	ÖLÇÜ PG	ÜRÜN KODU
M16	MPS12-M16	PG1	MPS12-PG9
M16	MPS16-M16	PG11	MPS16-PG11
M20	MPS16-M20	PG13	MPS16-PG13
M20	MPS20-M20	PG16	MPS20-PG16
M25	MPS25-M25	PG21	MPS25-PG21
M32	MPS32-M32	PG29	MPS32-PG29



Lastik Sonlama / Sleeves



ÇIKIŞ Ø	ÜRÜN KODU
5	ES10-13
5	ES14-17
7	ES17-20
8	ES19-22
9	ES21-24



ÖLÇÜ	ÜRÜN KODU
16	FPA16-FPA16
21	FPA21-FPA21
28	FPA28-FPA28
34	FPA34-FPA34
42	FPA42-FPA42
54	FPA54-FPA54

Spiral Ek Mufu IP66-IP67
 Polyamid Fittings



ÖLÇÜ	ÜRÜN KODU
16	FPA16T
21	FPA21T
28	FPA28T
34	FPA34T
42	FPA42T

T Bağlantı Elemanı
 T Connector



ÖLÇÜ	ÜRÜN KODU
16	FPA16-13-13
21	FPA21-16-16
28	FPA28-21-21
34	FPA34-28-28

Y Bağlantı Elemanı
 Y Connector



ÜRÜN KODU	SİRAL ÇAPI
FCLAMP -3 -16	16
FCLAMP -3 -21	21
FCLAMP -4 -28	28
FCLAMP -5 -34	34
FCLAMP -6 -42	42
FCLAMP -7 -67	67
FCLAMP -8 -80	80

FCLAMP



ÖLÇÜ	ÜRÜN KODU
16	EC16B
21	EC21B
28	EC28B
34	EC34B
42	EC42B
54	EC54B

EC Polyamid Sonlama
 End Cap



ÖLÇÜ metrik	ÜRÜN KODU
13	FCL13
16	FCL16
21	FCL21
28	FCL28
34	FCL34
42	FCL42

FCL Boru Klipsi / Clips



ÜRÜN KODU
FPA13-R16
FPA16-R21
FPA13-R21
FPA25-R28
FPA21-R28
FPA16-R28
FPA13-R28
FPA28-R34
FPA21-R34
FPA16-R34

Redüksiyon / Reducer



ÖLÇÜ	METRİK	PG	KOD
M12	LM12-N	PG9	PG9-N
M16	LM16-N	PG11	PG11-N
M20	LM20-N	PG13	PG13-N
M25	LM25-N	PG16	PG16-N
M32	LM32-N	PG21	PG21-N
M40	LM40-N	PG29	PG29-N
M50	LM50-N	PG36	PG36-N
M63	LM63-N	PG42	PG42-N
M75	LM75-N	PG48	PG48-N

LM Polyamid Somun
 Locknuts



EN 45545-2
DIN 5510
BS 6853

NFPA 130
LUL 1-085
AS/NZS 1530.3



FPR Polyamid Spiral Boru (PA6)
Polyamid Halogenfree Conduit



Demiryolları, metrolarda ve sanayi tesislerinde kullanılır.
Koruma Sınıfı / Protection Rating: IP 66, IP67, IP68, IP69K
Çalışma Sıcaklığı / Temperature Range: -40° C - +120° C
Solvent ve yağlara karşı yüksek dayanım / Highly resistant to solvents and oils
Halogen, sulphur and phosphorus free
Aşınmalara karşı yüksek dayanım / Abrasion resistant

UL recognized
Lloyd's register type approval
Yangına karşı ekstra koruma UL94 V0 / Extra low fire hazard
UL94 V0 flame retardancy
UV Resistant
Compliant to LUL Std 1-085

ÜRÜN KODU	İÇ ÇAP mm	DIŞ ÇAP mm	MİN. BÜKÜLME ÖLÇÜSÜ mm	RULO UZUNLUĞU mt
FPR10	6,3	10	15	50
FPR13	9,8	13	25	50
FPR16	11,8	15,8	35	50
FPR21	16,7	21,2	45	50
FPR28	21,7	28,5	50	50
FPR34	28,1	34,5	60	50
FPR42	35,5	42,5	70	25
FPR54	42,2	54,5	80	25

EN 45545-2
NFPA 130



FPIHR Polyamid Spiral Boru (PA12)
Polyamid Halogenfree Conduit



Demiryolları, metrolarda ve sanayi tesislerinde kullanılır.
Koruma Sınıfı / Protection Rating: IP 66, IP67, IP68, IP69K
Çalışma Sıcaklığı / Temperature Range: -50° C - +110° C
Solvent ve yağlara karşı yüksek dayanım / Highly resistant to solvents and oils
Halogen, sulphur and phosphorus free
Aşınmalara karşı yüksek dayanım / Abrasion resistant

UL recognized
Lloyd's register type approval
Yangına karşı ekstra koruma / Extra low fire hazard flame retardancy
UV Resistant
Self extinguishing
Compliant to LUL Std 1-085

ÜRÜN KODU	İÇ ÇAP mm	DIŞ ÇAP mm	MİN. BÜKÜLME ÖLÇÜSÜ mm	RULO UZUNLUĞU mt
FPIHR13	9.0	13.0	25	50
FPIHR16	11.5	15.8	35	50
FPIHR21	15.0	21.2	45	50
FPIHR28	21.3	28.5	50	50
FPIHR34	27.6	34.5	60	25
FPIHR42	34.6	42.5	70	25
FPIHR54	46.0	54.5	80	25



FPIHSS Çelik Örgülü Polyamid Spiral Boru
Nylon Stainless Steel Overbraid



ÜRÜN KODU	İÇ ÇAP mm	DIŞ ÇAP mm	MİN. BÜKÜLME ÖLÇÜSÜ mm	RULO UZUNLUĞU mt
FPIHSS16	11,5	17,3	35	50
FPIHSS21	15	22,7	45	50
FPIHSS28	21,3	30,0	50	50
FPIHSS34	26,9	36,0	60	25
FPIHSS42	35,5	44,0	70	25
FPIHSS54	47,2	46,0	80	25

Metro ve tren istasyonlarında kullanılır. / Metrorail stations for anti-vandal.
Koruma Sınıfı / IP Rating: IP67
Çalışma Sıcaklığı / Temperature Range: -50° C - +110° C
Vibration & shock tested to EN61373 Cat 2
Yüksek darbe dayanımı / Provides high tensile strength and resistance to abrasion, corrosion and vandals
Provides EMC Screening 49dB@1MHz





FPA RAKOR



ÜRÜN KODU METRİK	ÜRÜN KODU PG	DIŞ ÇAP	ÖLÇÜ
FPA13 - BM13	FPA13 - BPG9	13.0	13
FPA16 - BM16	FPA16 - BPG9	15.8	16
FPA16 - BM20	FPA16 - BPG11		16
FPA21 - BM20	FPA21 - BPG13	21.2	21
FPA28 - BM25	FPA21 - BPG16	28.5	28
FPA34 - BM32	FPA28 - BPG21	34.5	34
FPA42 - BM40	FPA34 - BPG29	42.5	42
FPA42 - BM50	FPA42 - BPG36		42
FPA54 - BM50	FPA54 - BPG48	54.5	54
FPA54 - BM63			54
FPA67 - BM63		67.0	67



FPA RAKOR



ÜRÜN KODU METRİK	ÜRÜN KODU PG	DIŞ ÇAP	ÖLÇÜ
FPA13 - BFM13	FPA13 - BFPG9	13.0	13
FPA16 - BFM16	FPA16 - BFPG11	15.8	16
FPA16 - BFM20	FPA16 - BFPG16		16
FPA21 - BFM20	FPA21 - BFPG16	21.2	21
FPA28 - BFM25	FPA28 - BFPG21	28.5	28
FPA34 - BFM32	FPA34 - BFPG29	34.5	34
FPA42 - BFM40	FPA42 - BPG36	42.5	42
FPA 54 - BFM50			54



FPA90 RAKOR



ÜRÜN KODU METRİK	ÜRÜN KODU PG	DIŞ ÇAP	ÖLÇÜ
FPA13 - BM16 -90	FPA13 - BPG9 -90	13.0	13
FPA16 - BM16 -90	FPA16 - BPG9 -90	15.8	16
FPA16 - BM20 -90	FPA16 - BPG11 -90		16
FPA21 - BM20 -90	FPA21 - BPG13 -90	21.2	21
FPA28 - BM25 -90	FPA21 - BPG16 -90	28.5	28
FPA34 - BM32 -90	FPA28 - BPG21 -90	34.5	34
FPA42 - BM40 -90	FPA34 - BPG29 -90	42.5	42
FPA42 - BM50 -90	FPA42 - BPG36 -90		42
FPA54 - BM50 -90	FPA54 - BPG48 -90	54.5	54
FPA54 - BM63 -90			54



BC RAKOR



ÜRÜN KODU	ÖLÇÜ
BC16 -M16 -C	16
BC21 -M21 -C	20
BC28 -M25 -C	25
BC34 -M32 -C	32
BC42 -M40 -C	40
BC54 -M50 -C	50

 **EXPROOF EKİPMANLAR**
EXPROOF EQUIPMENTS

www.deltafleks.com
info@deltafleks.com



ExProof Floresan Armatürler IP67/ Exproof Fluorescent Tubes



- Alüminyum gövdeli, tavan tipi ve mekanik balastlıdır.
- Çalışma ortam sıcaklığı -20°C _ +55°C' dir.
- Zone 1 / Zone 2, Zone 21 / Zone 22 sahalarda kullanılmaya uygundur.

ÜRÜN KODU	AMPUL GÜCÜ	AMPUL TİPİ	DUY TİPİ	GİRİŞ DİŞ ÖLÇÜSÜ	VOLTAJ	ÖLÇÜLER EnxBoyx-Yüks	AĞIRLIK (kg)
EVFC118R	1X18 / 20W	T8	G13	2X3/4"	220~240V - 50Hz	106x910x98	6,2
EVFC218R	2X18 / 20W	T8	G13	2X3/4"	220~240V - 50Hz	206x910x98	11,5
EVFC136R	1X36 / 40W	T8	G13	2X3/4"	220~240V - 50Hz	106x1530x98	9
EVFC236R	2X36 / 40W	T8	G13	2X3/4"	220~240V - 50Hz	206x1530x98	16,9
EVFC158R	1X58 / 65W	T8	G13	2X3/4"	220~240V - 50Hz	106x1840x98	14,6
EVFC258R	2X58 / 65W	T8	G13	2X3/4"	220~240V - 50Hz	206x1840x98	26,4

ExProof Acil Durum Aydınlatma Armatürleri IP66/ Exproof Emergency Fluorescent Tubes



- Alüminyum gövdeli, tavan tipi ve mekanik balastlıdır.
- Çalışma ortam sıcaklığı -20°C _ +55°C' dir.
- Zone 1 / Zone 2, Zone 21 / Zone 22 sahalarda kullanılmaya uygundur.

ÜRÜN KODU	AMPUL GÜCÜ	AMPUL / DUY TİPİ	KİT SÜRESİ	GİRİŞ DİŞ ÖLÇÜSÜ	VOLTAJ	ÖLÇÜLER EnxBoyx-Yüks	AĞIRLIK (kg)
EVFEC118R	1X18 / 20W	T8 / G13	120 Dk.	2X3/4"	220~240V - 50Hz	106x910x230	6,2
EVFEC218R	2X18 / 20W	T8 / G13	120 Dk.	2X3/4"	220~240V - 50Hz	206x910x230	11,5
EVFEC136R	1X36 / 40W	T8 / G13	90 Dk.	2X3/4"	220~240V - 50Hz	106x1530x230	9
EVFEC236R	2X36 / 40W	T8 / G13	90 Dk.	2X3/4"	220~240V - 50Hz	206x1530x230	16,9
EVFEC158R	1X58 / 65W	T8 / G13	60 Dk.	2X3/4"	220~240V - 50Hz	106x1840x230	14,6
EVFEC258R	2X58 / 65W	T8 / G13	60 Dk.	2X3/4"	220~240V - 50Hz	206x1840x230	26,4

ExProof Floresan Aydınlatma Armatürleri IP66/ Fluorescent Tubes



- Polyester gövdeli, tavan tipi ve elektronik balastlıdır.
- Çalışma ortam sıcaklığı -20°C _ +50°C' dir.
- Armatür üzerinde 1 adet körtapa bulunmaktadır.
- Zone 1 / Zone 2, Zone 21 / Zone 22 sahalarda kullanılmaya uygundur.

ÜRÜN KODU	AMPUL GÜCÜ	AMPUL	DUY TİPİ	GİRİŞ DİŞ ÖLÇÜSÜ	VOLTAJ	ÖLÇÜLER EnxBoyx-Yüks	AĞIRLIK (kg)
AVFC118R	1X18 / 20W	T8	G13	2XM25	220~240V - 50Hz	215x732x162	5
AVFC218R	2X18 / 20W	T8	G13	2XM25	220~240V - 50Hz	215x732x162	5,2
AVFC136R	1X36 / 40W	T8	G13	2XM25	220~240V - 50Hz	215x1342x162	7,2
AVFC236R	2X36 / 40W	T8	G13	2XM25	220~240V - 50Hz	215x1342x162	7,4



Ex II 2 GD EEx d IIC / EExe II

Zırhsız Kablo Rakoru - IP67
Non Armoured Cable Glands



Pirinç üzeri nikel kaplı imal edilmektedir.
ATEX sertifikalıdır
Neopren contası -20° C, 40° C arası dayanıklıdır.
Zırhsız kabloların bağlantılarında kullanılır.

NPT KOD	NPT ÖLÇÜ	METRİK ÜRÜN KODU	METRİK DIŞ ÖLÇÜ	SIKMA ARALIĞI (mm)
PNA-0D	1/2"	PNA-0MD	M20X1,5	4-10
PNA-1D	1/2"	PNA-1MD	M20X1,5	6-12
PNA-12D	3/4"	PNA-2AMD	M25X1,5	6-12
PNA-2D	1"	PNA-2BMD	M25X1,5	9-17
PNA-3D	1 1/4"	PNA-3MD	M32X1,5	14-23
PNA-5AD	1 1/2"	PNA-5AMD	M40X1,5	19-29
PNA-5BD	2"	PNA-5BMD	M50X1,5	28-36
PNA-6D	2 1/2"	PNA-6MD	M63X1,5	34-45
PNA-8D	3"	----	----	47-59



Ex II 2 GD EEx d IIC / EExe II

Zırhlı Kablo Rakoru IP68 E1-WF
Armoured Cable Glands



Pirinç üzeri nikel kaplı imal edilmektedir.
ATEX-IECEX-CSA-GOST-R sertifikalıdır
Neopren contası -20° C, 85° C arası dayanıklıdır.
Zırhlı kabloların bağlantılarında kullanılır.

NPT ÜRÜN KODU	NPT DIŞ ÖLÇÜ	METRİK ÜRÜN KODU	METRİK DIŞ ÖLÇÜ	ZIRHSIZ SIKMA ARALIĞI (mm)	ZIRHLI SIKMA ARALIĞI (mm)
E1WF/NP/16"	1/2"	E1WF/NP/16/M20	M20X1,5	4-8,4	8,4-13,5
E1WF/NP/20S"	1/2"	E1WF/NP/20S/M20	M20X1,5	8-11,7	11,5-16
E1WF/NP/20"	3/4"	E1WF/NP/20/M20	M20X1,5	6,7-14	15,5-21,1
E1WF/NP/25"	3/4"	E1WF/NP/25/M25	M25X1,5	13-20	20,3-27,4
E1WF/NP/32/1"	1"	E1WF/NP/32/M32	M32X1,5	19-26,3	26,7-34
E1WF/NP/40/1"	1 1/2"	E1WF/NP/40/M40	M40X1,5	25-32,2	33-40,6
E1WF/NP/50S/1"	1 1/2"	E1WF/NP/50S/M50	M50X1,5	31,5-38,2	39,4-46,7
E1WF/NP/50/2"	2"	E1WF/NP/50/M50	M50X1,5	36,5-44,1	45,7-53,2
E1WF/NP/63S/2"	2"	E1WF/NP/63S/M63	M63X1,5	42,4-50,1	52,1-59,5
E1WF/NP/63/2"	2 1/2"	E1WF/NP/63/M63	M63X1,5	49,5-56	58,4-65,8
E1WF/NP/75S/3"	3"	E1WF/NP/75S/M75	M75X1,5	54,5-62	64,8-72,2
E1WF/NP/75/3"	3"	E1WF/NP/75/M75	M75X1,5	60,5-68	71,1-78



Rakor Topraklama Pulu
Earthing Rings



ÜRÜN KODU	RAKOR ÖLÇÜSÜ	ÜRÜN KODU	RAKOR ÖLÇÜSÜ
ACBET/NP/M16	M16x1,5	ACBET/NP/3/8"	3/8"
ACBET/NP/M20	M20x1,5	ACBET/NP/1"	1/2"
ACBET/NP/M25	M25x1,5	ACBET/NP/1"	3/4"
ACBET/NP/M32	M32x1,5	ACBET/NP/1"	1"
ACBET/NP/M40	M40x1,5	ACBET/NP/1"	1"



Kauçuk Rakor Kılıfı
Shrouds



ÜRÜN KODU	RAKOR ÖLÇÜSÜ	RAKOR ÖLÇÜSÜ
ACSPCP/L24	M20	1/2"
ACSPCP/L30		3/4"
ACSPCP/L38	M25	3/4"
ACSPCP/L46	M32	1"
ACSPCP/L55	M40	1"



Paslanmaz Çelik Rakorlu Spiral
SS Flexible Conduit with Fittings



50 cm KODU	100 cm KODU	ÖLÇÜ	HORTUM İÇ ÇAPI
FNN1-50	FNN1-100	1/2"	14 mm
FNN2-50	FNN2-100	3/4"	19 mm
FNN3-50	FNN3-100	1"	25 mm



ÜRÜN KODU	ÖLÇÜ
BMF-1	1/2"
BMF-2	3/4"
BMF-3	1"
BMF-5	1 1/2"
BMF-6	2"

Üç Parçalı Boru Rakoru Erkek-Dişi
Three Piece Type Fittings Male-Female



ÜRÜN KODU	ÖLÇÜ
BFF-1	1/2"
BFF-2	3/4"
BFF-3	1"
BFF-5	1 1/2"
BFF-6	2"

3 Parçalı Boru Rakoru Dişi-Dişi
Three Piece Type Fittings Female-Female



ÜRÜN KODU	ÖLÇÜ
NP-1	1/2"
NP-2	3/4"
NP-3	1"
NP-5	1 1/2"
NP-6	2"

Nipel / Nipples



ÜRÜN KODU	ÖLÇÜ
EMU-1	1/2"
EMU-2	3/4"
EMU-3	1"
EMU-5	1 1/2"
EMU-6	2"

Manşon / Couplings



ÜRÜN KODU	ÖLÇÜ
PLG-1	1/2"
PLG-2	3/4"
PLG-3	1"
PLG-5	1 1/2"
PLG-6	2"

Kör Tapa NPT Diş / Plugs NPT



ÜRÜN KODU	ÖLÇÜ
PLG-1M	M20x1,5
PLG-2M	M25x1,5
PLG-3M	M32x1,5
PLG-4M	M50x1,5
PLG-5M	M63x1,5

Kör Tapa Metrik Diş / Plugs Metric



ÜRÜN KODU	ÖLÇÜ
ELF-1	1/2"
ELF-2	3/4"
ELF-3	1"
ELF-5	1 1/2"
ELF-6	2"

Dirsek / Elbow



ÜRÜN KODU	MİKTAR (Gr)
MCK-250	250
MCK-500	500
MCK-1000	1000

Dondurucu & Fiber İp / Compounds





Düşey Durdurucu
Vertical Sealing Fittings



ÜRÜN KODU	ÖLÇÜ	DONDURUCU GR.
EYS-1	1/2"	25
EYS-2	3/4"	50
EYS-3	1"	80



Yatay Durdurucu
Horizontal Sealing Fittings



ÜRÜN KODU	ÖLÇÜ	DONDURUCU GR.
EZS-1	1/2"	110
EZS-2	3/4"	125
EZS-3	1"	180
EZS-5	1 1/2"	300
EZS-6	2"	450



"RE" Tip Erkek Dişi Dönüştürücü
"RE" Type Reducer



ÜRÜN KODU	ERKEK ÖLÇÜ	DIŞİ ÖLÇÜ
RE-21	3/4"	1/2"
RE-31	1"	1/2"
RE-32	1"	3/4"
RE-51	1 1/2"	1/2"
RE-52	1 1/2"	3/4"
RE-53	1 1/2"	1"
RE-61	2"	1/2"
RE-62	2"	3/4"
RE-63	2"	1"



"REB" Tip Erkek Dişi Dönüştürücü
"REB" Type Reducer



ÜRÜN KODU	ERKEK ÖLÇÜ	DIŞİ ÖLÇÜ
REB-21	3/4"	1/2"
REB-31	1"	1/2"
REB-32	1"	3/4"
REB-51	1 1/2"	1/2"
REB-52	1 1/2"	3/4"
REB-53	1 1/2"	1"
REB-61	2"	1/2"
REB-62	2"	3/4"
REB-63	2"	1"



"REM" Tip Dişi Dişi Dönüştürücü
"REM" Type Reducer



ÜRÜN KODU	ERKEK ÖLÇÜ	DIŞİ ÖLÇÜ
REM-21	3/4"	1/2"
REM-31	1"	1/2"
REM-32	1"	3/4"
REM-51	1 1/2"	1/2"
REM-52	1 1/2"	3/4"
REM-53	1 1/2"	1"
REM-61	2"	1/2"
REM-62	2"	3/4"
REM-63	2"	1"

EJB/EJB..F Tipi Kapaklı ve Cam Kapaklı İrtibat Kutuları / Junction Boxes



16A 32A IP65
Zone 1 / Zone 2
Max. 415V AC
RAL 7040 Gri
Ex II 2G Ex de IIB T6 (16A) T5 (32A)

63A 100A IP54+IP65
Zone 1 / Zone 2, Zone 21 / Zone 22
Max. 415V AC
RAL 7040 Gri
Ex II 2G Ex d IIB T4

ÜRÜN KODU	DIŞ ÖLÇÜLER (mm)			İÇ ÖLÇÜLER (mm)			Montaj Delikleri (mm)		Vida Çapı	Buton Adedi	
	BOY	EN	YÜKSEKLİK	BOY	EN	YÜKSEKLİK	x	y	øF	Nx	Ny
EJB-544	175	150	120	130	104	91	94	120	M5	2	1
EJB-755	212	175	140	164	125	116	100	140	M6	3	2
EJB-1076	305	206	157	252	154	127	132	224	M6	4	3
EJB-1286	370	265	200	306	203	158	164	280	M8	5	3
EJB-14107	450	307	206	375	232	169	198	339	M8	6	4

ExProof GUB Tipi İrtibat Kutuları IP66/ Junction Boxes



Hafif alaşımli alüminyum malzemeden üretilmektedir. Özellikle kablo çekme kutusu olarak kullanılmaktadır. İstenildiği takdirde montaj plakası, cihaz, şalter, trafo vb. monte edilebilir. İsteğe bağlı conta ile kullanıldığında IP66 özellikli olabilir.

ÜRÜN KODU	DIŞ ÖLÇÜLER (mm)			İÇ ÖLÇÜLER (mm)			Montaj Delikleri (mm)		Vida Çapı
	BOY	EN	YÜKSEKLİK	BOY	EN	YÜKSEKLİK	x	y	øF
GUB-20	144	144	119	116	116	70	108	169	M8
GUB-30	174	165	142	130	140	74	136	190	M10
GUB-40	252	213	163	178	216	90	206	248	M12
GUB-50	305	280	221	248	272	125	265	320	M12

ExProof Elektrik Anahtarları IP66/ Rotary Switches



Alüminyum gövdelidir. Çalışma ortam sıcaklığı -20°C _ +40°C' dir. Zone 1 / Zone 2, Zone 21 / Zone 22 sahalarda kullanılmaya uygundur.

ÜRÜN KODU	FSPC-210	FSPC-410	FSPC-325	FSPC-425	EFD+	EFD-52	EFD-502	EFD-503
KUTUP SAYISI	2	4	3	4	1	1	1	3
AKIM	16A	16A	32A	32A	16A	16A	16A	16A
GİRİŞ DIŞ ÖLÇÜSÜ	2x3/4"	2x3/4"	2x1"	2x3/4"	2x3/4"	2x3/4"	2x3/4"	2x3/4"
KONTAK YAPISI	0-1	0-1	0-1	0-1	0-1-2	1-2	1-0-2	1-0-2

ExProof Döküm Pirizler IP65/ Sockets



Alüminyum gövdelidir. BP tip fişi ile kilitleme özelliğine sahiptir. Çalışma ortam sıcaklığı -20°C _ +40°C' dir. Zone 1 / Zone 2 sahalarda kullanılmaya uygundur.

ÜRÜN KODU	FSQ-215	FSQ-325	FSQ-425	FSQ-360	FSQ-460
KUTUP SAYISI	2P+E	3P+E	3P+N+E	3P+E	3P+N+E
AKIM	25A	32A	32A	63A	63A
VOLTAJ	500V	500V	500V	500V	500V
GİRİŞ DIŞ ÖLÇÜSÜ	1"	1"	1"	1 1/2"	1 1/2"



ÜRÜN KODU	ÖLÇÜ
SC-14	1/2"
SC-26	3/4"
SC-36	1"
SC-59	1 1/2"
SC-69	2"

ExProof İki Yollu C Tipi İrt. Kutusu IP65
Round Junction Box



ÜRÜN KODU	ÖLÇÜ
SL-14	1/2"
SL-26	3/4"
SL-36	1"
SL-59	1 1/2"
SL-69	2"

ExProof İki Yollu L Tipi İrt. Kutusu IP65
Round Junction Box



ÜRÜN KODU	ÖLÇÜ
ST-14	1/2"
ST-26	3/4"
ST-36	1"
ST-59	1 1/2"
ST-69	2"

ExProof Üç Yollu T Tipi İrt. Kutusu IP65
Round Junction Box



ÜRÜN KODU	ÖLÇÜ
SX-14	1/2"
SX-26	3/4"
SX-36	1"
SX-59	1 1/2"
SX-69	2"

ExProof Dört Yollu X Tipi İrt. Kutusu IP65
Round Junction Box



ÜRÜN KODU	ÖLÇÜ
BHD-B 1/2"	1/2"
BHD-B 3/4"	3/4"
BHD-B 1"	1"

ExProof İki Yollu B Tipi İrt. Kutusu IP65
Round Junction Box



ÜRÜN KODU	ÖLÇÜ
BHD-E 1/2"	1/2"
BHD-E 3/4"	3/4"
BHD-E 1"	1"

ExProof İki Yollu E Tipi İrt. Kutusu IP65
Round Junction Box



ÜRÜN KODU	ÖLÇÜ
BHD-C 1/2"	1/2"
BHD-C 3/4"	3/4"
BHD-C 1"	1"

ExProof Üç Yollu C Tipi İrt. Kutusu IP65
Round Junction Box



ÜRÜN KODU	ÖLÇÜ
BHD-D 1/2"	1/2"
BHD-D 3/4"	3/4"
BHD-D 1"	1"

ExProof Dört Yollu D Tipi İrt. Kutusu IP65
Round Junction Box



ÜRÜN KODU	ÖLÇÜ
LLH-1	1/2"
LLH-2	3/4"
LLH-3	1"
LLH-5	1 1/2"
LLH-6	2"

ExProof LLH Tip Kapaklı Dirsek IP65 / Pulling Elbow



ÜRÜN KODU	ÖLÇÜ
LBH-1	1/2"
LBH-2	3/4"
LBH-3	1"
LBH-5	1 1/2"
LBH-6	2"

ExProof LBH Tip Kapaklı Dirsek IP65 / Open Elbows



PVC Spiral Boru Hafif Seri / Light Gage Self Extinguishing



Özellik : Alev yaymayan - Esnek tesisat borusu.
Malzeme : PVC bazlı termoplastik.
Sıkışma Dayanımı : 320 Newton / 60 sn. / 23 ± 2°C Sınıf/2
Darbe Dayanımı : 1kg / 100mm / -25°C Sınıf/2
Sıcaklık Dayanımı : -25°C / +60°C Sınıf/4/1
Renk : Gri, siyah, beyaz, yeşil, mavi, lacivert, eflatun, kahve
Kullanım Alanları : Asma tavan, tuğla duvar, alçıpan duvar içi tesisatlarda.

Anma Çapı	Ø16	Ø20	Ø25	Ø32	Ø40	Ø50	Ø63
Kod No	SC1-016	SC1-020	SC1-025	SC1-032	SC1-040	SC1-050	SC1-063
İç Çap (mm)	11,2	14,5	18,5	24,5	31,2	39,6	52,5
Dış Çap (mm)	16	20	25	32	40	50	63
Ambalaj (m)	100	100	50	50	50	25	15

PVC Spiral Boru Ağır Seri / Heavy Gage Self Extinguishing



Özellik : Alev yaymayan - Esnek tesisat borusu.
Malzeme : PVC bazlı termoplastik.
Sıkışma Dayanımı : 750 Newton / 60 sn. / 23 ± 2°C Sınıf/3
Darbe Dayanımı : 2kg / 100mm / -25°C Sınıf/3
Sıcaklık Dayanımı : -25°C / +60°C Sınıf/4/1
Renk : Gri, siyah, beyaz, yeşil, mavi, lacivert, eflatun, kahve
Kullanım Alanları : Beton içi, harici ve toprak altı tesisatlarda.

Anma Çapı	Ø16	Ø20	Ø25	Ø32	Ø40	Ø50	Ø63
Kod No	SC3-016	SC3-020	SC3-025	SC3-032	SC3-040	SC3-050	SC3-063
İç Çap (mm)	11,2	14,5	18,5	24,5	31,2	39,6	52,5
Dış Çap (mm)	16	20	25	32	40	50	63
Ambalaj (m)	100	100	50	50	50	25	15

PE / HF Kangal Boru Hafif Seri / Light Gage Halogen Free



Özellik : Alev yayan - H.Free Esnek tesisat borusu.
Malzeme : PE bazlı termoplastik.
Sıkışma Dayanımı : 320 Newton / 60 sn. / 23 ± 2°C Sınıf/2
Darbe Dayanımı : 1kg / 100mm / -25°C Sınıf/3
Sıcaklık Dayanımı : -25°C / +60°C Sınıf/4/1
Kullanım Alanları : Beton içi, harici ve toprak altı tesisatlarda.

Anma Çapı	Ø16	Ø20	Ø25	Ø32	Ø40	Ø50	Ø63	Ø75	Ø90
Kod No	SP1-016	SP1-020	SP1-025	SP1-032	SP1-040	SP1-050	SP1-063	SP1-075	SP1-090
İç Çap (mm)	13,2	17	21,4	27,8	35	44,4	57	68,2	82,4
Dış Çap (mm)	16	20	25	32	40	50	63	75	90
Ambalaj (m)	200	200	100	100	50	25	25	25	15

PE / HF Kangal Boru Ağır Seri / Heavy Gage Halogen Free



Özellik : Alev yayan - H.Free Esnek tesisat borusu.
Malzeme : PE bazlı termoplastik.
Sıkışma Dayanımı : 750 Newton / 60 sn. / 23 ± 2°C Sınıf/3
Darbe Dayanımı : 2kg / 100mm / -25°C Sınıf/3
Sıcaklık Dayanımı : -25°C / +60°C Sınıf/4/1
Kullanım Alanları : Beton içi, harici ve toprak altı tesisatlarda.

Anma Çapı	Ø16	Ø20	Ø25	Ø32	Ø40	Ø50	Ø63	Ø75	Ø90
Kod No	SP3-016	SP3-020	SP3-025	SP3-032	SP3-040	SP3-050	SP3-063	SP3-075	SP3-090
İç Çap (mm)	12,4	16	19,6	25,4	32,6	42	54,4	65,6	79,6
Dış Çap (mm)	16	20	25	32	40	50	63	75	90
Ambalaj (m)	200	200	100	100	50	25	25	25	15

Hafif Seri / Light Gage Self Extinguishing



Özellik	: Alev yaymayan - Bükülebilir tesisat borusu.
Malzeme	: PVC bazlı termoplastik.
Sıkışma Dayanımı	: 320 Newton / 60 sn. / 23 ± 2°C Sınıf/2
Darbe Dayanımı	: 1kg / 100mm / -25°C Sınıf/2
Sıcaklık Dayanımı	: -25°C / +60°C Sınıf/4/1
Renk	: Gri, siyah, beyaz
Kullanım Alanları	: Sıva üstü, sıva altı ve asma tavan içi tesisatlarda.

Anma Çapı	Ø16	Ø20	Ø25	Ø32
Kod No	SR1-316	SR1-320	SR1-325	SR1-332
İç Çap (mm)	13,4	17	22,1	28,2
Dış Çap (mm)	16	20	25	32
Ambalaj (m)	102	102	75	51

Orta Seri / Medium Gage Self Extinguishing



Özellik	: Alev yaymayan - Bükülebilir tesisat borusu.
Malzeme	: PVC bazlı termoplastik.
Sıkışma Dayanımı	: 750 Newton / 60 sn. / 23 ± 2°C Sınıf/3
Darbe Dayanımı	: 1kg / 100mm / -25°C Sınıf/2
Sıcaklık Dayanımı	: -25°C / +60°C Sınıf/4/1
Renk	: Gri, siyah, beyaz
Kullanım Alanları	: Sıva üstü, sıva altı ve şap beton içi tesisatlarda.

Anma Çapı	Ø16	Ø20	Ø25	Ø32
Kod No	SR2-316	SR2-320	SR2-325	SR2-332
İç Çap (mm)	12,8	16,6	21	27,5
Dış Çap (mm)	16	20	25	32
Ambalaj (m)	102	102	75	51

Ağır Seri / Heavy Gage Self Extinguishing



Özellik	: Alev yaymayan - Bükülebilir tesisat borusu.
Malzeme	: PVC bazlı termoplastik.
Sıkışma Dayanımı	: 1250 Newton / 60 sn. / 23 ± 2°C Sınıf/4
Darbe Dayanımı	: 1kg / 100mm / -25°C Sınıf/3
Sıcaklık Dayanımı	: -25°C / +60°C Sınıf/4/1
Renk	: Gri, siyah, beyaz
Kullanım Alanları	: Beton içi, harici ve toprak altı tesisatlarda.

Anma Çapı	Ø16	Ø20	Ø25	Ø32
Kod No	SR3-316	SR3-320	SR3-325	SR3-332
İç Çap (mm)	11,9	15,7	20,2	26,2
Dış Çap (mm)	16	20	25	32
Ambalaj (m)	102	102	75	51

ÜRÜN KODU	ÇAP Ø (mm)	ÖLÇÜ
CF-16	16	100
CF-20	20	100
CF-25	25	100
CF-32	32	100
CF-40	40	50
CF-50	50	25

Yarımay Kroşe / Conduit Clips



ÜRÜN KODU	ÇAP Ø (mm)	ÖLÇÜ
GFLEX-16	16	100
GFLEX-20	20	100
GFLEX-25	25	100
GFLEX-32	32	100
GFLEX-40	40	50
GFLEX-50	50	25

Ek Muf / Couplers





ÜRÜN KODU	ÇAP Ø (mm)	Paket Miktarı
GSU-16	16	100
GSU-20	20	100
GSU-25	25	100
GSU-32	32	50

Ek Muf IP40 / Couplers



ÜRÜN KODU	ÇAP Ø (mm)	Paket Miktarı
CRS-16	16	100
CRS-20	20	100
CRS-25	25	100
CRS-32	32	100

90° Dirsek IP40 / Elbow

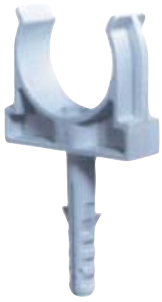

ÜRÜN KODU	ÇAP Ø (mm)	Paket Miktarı
CT-16	16	100
CT-20	20	100
CT-25	25	100
CT-32	32	50

Vidalı Dübelli Kroşe / Clips with Dowels



ÜRÜN KODU	ÇAP Ø (mm)	Paket Miktarı
C-12	12÷20	100
C-16	14÷22	100
C-25	23÷35	50
C-50	38÷50	50

Kapaklı Kroşe / Clips



ÜRÜN KODU	ÇAP Ø (mm)	Paket Miktarı
TI-16	16	100
TI-20	20	100
TI-25	25	50
TI-32	32	50

Açılır T IP40 / T Connectors



ÜRÜN KODU	ÇAP Ø (mm)	Paket Miktarı
CI-16	16	100
CI-20	20	100
CI-25	25	100
CI-32	32	50

Açılır 90° Dirsek IP40 / Elbow



ÜRÜN KODU	ÇAP Ø (mm)	Paket Miktarı
BA-16	16	1
BA-20	20	1
BA-25	25	1

Düz Boru Bükme Aparatı / Conduit Bender



ÜRÜN KODU	ÇAP Ø (mm)	Paket Miktarı
BS-16	16	50
BS-20	20	50
BS-25	25	50
BS-32	32	25

Düz Boru Kutu Adaptörü IP65 / Box Connector



hager

DELTA FLEX
Spiral Boru & EMT Boru & Exproof Malzemeler

B.
Berker

ANAHTAR PİRİZ SİSTEMLERİ
SWITCH & SOCKET SYSTEMS

www.deltafleks.com
info@deltafleks.com

Berker Integro

Mobilya, Laboratuvar, Tekne, Karavan...

Her Alana Minimal Boyutta Alternatif Çözümler

Modern tasarım çeşitliliğiyle ihtiyaçlarınızı mükemmel bir şekilde karşılayan Berker Integro, küçük yapısı sayesinde birçok sisteme kolayca entegre edilebilmektedir. Boyutunun verdiği avantaj sayesinde oldukça az bir yer kaplar. Minimal yapıda olma özelliği, mobilya, tekne ve laboratuvar gibi özel kullanım alanlarında Berker Integro'yu akla gelen ilk tercih yapmaktadır. Berker Integro, küçük olduğu kadar kullanışlı olan tasarımı sayesinde, 2'li ya da 3'lü çerçeve kombinasyonlarıyla her mekanda istediğiniz şekilde kullanılabilir.



59,5 mm

59,5 mm



Integro flow: kahverengi, antrasit, parlak gri, parlak beyaz, parlak siyah, krom lacquered, paslanmaz çelik lacquered.

Integro classic: kahverengi, parlak gri, parlak beyaz, mat siyah, mat granit siyah lacquered, parlak krom, parlak altın.

Integro pure: parlak beyaz, parlak siyah, mat granit siyah lacquered, paslanmaz çelik lacquered, parlak krom, mat krom.

Berker Serie 1930

Nostalji Tadında Mükemmel Kontrol

Sade hatları ve fonksiyonelliğiyle Serie 1930, eskimeyen klasik tarzın son teknoloji ile buluşmasından ortaya çıktı. Dekorasyonda nostaljiden hoşlananların tercihi olan Serie 1930, kullanışlı ve sade bir görünümle klasik bir şıklık sunuyor. Aynı zamanda otomasyon sistemine uyumlu hale getirilebilen Serie 1930 ile, aydınlatmayı kontrol edebildiğiniz gibi tek bir dokunuşla perde - panjur, ısıtma ya da müzik sistemini de ayarlayabilirsiniz.



Renk/yüzey seçenekleri: plastik / siyah ve beyaz.



Renk/yüzey seçenekleri: siyah ve beyaz Rosenthal porselen.



Üzeri Seri 1930 kapıma



Üzeri Seri Gerçek Altın Çerçeve



Berker R.1

Klasik Çizgilere Modern Dokunuşlar

Berker, R.1 serisi ile klasik anahtar formlarına bir yenisini daha ekliyor. R.1 serisi, yuvarlak hatları ve kontürlü çerçevesiyle farklı olmayı Berker tarzıyla yansıtıyor. Fonksiyonel renk ve materyal alternatifleriyle tüm konut ve mobilya projeleri için ideal ve estetik çözümler sunuyor.



Renk/yüzey seçenekleri: paslanmaz çelik, alüminyum, beyaz cam, siyah cam, plastik beyaz, plastik siyah, taş, beton, boyalı meşe, kahverengi deri, akrilik fuşya, akrilik turuncu

Berker R.3

Keskin ve Dairesel Tarzın Mükemmel Uyumunu

Berker R.3, dairesel kenarlı keskin çerçeve ile kombine edilerek özel bir tarzda birleştiriliyor. Berker R.3 ile ideal mimari çözüm ve kolay montaj özelliği bir arada sunuluyor. Farklı renk / materyal alternatifleriyle de her konsept ve beğeniye uygun, şık seçenekler bulunuyor.

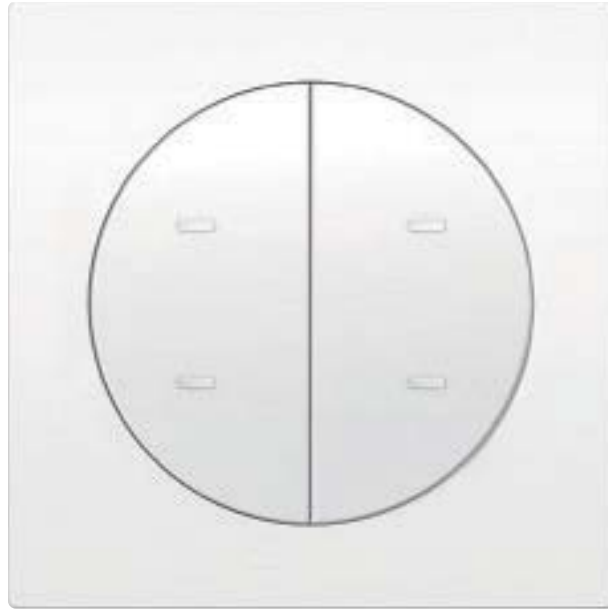

Özel Seri
Siyah krom



Özel Seri
Saten altın



Özel Seri
Mat safir mavi ve Mat gri



Renk/yüzey seçenekleri: paslanmaz çelik, alüminyum, beyaz cam, siyah cam, beyaz plastik, siyah plastik.

Berker by Hager Anahtar-Priz

Berker B.3



Berker B.7



Berker K.1 - K.3



Berker Q.1



Berker Q.3



Berker, tasarımları ve her zevke uygun renk alternatifleri ile mekanlara seçkin ve fark yaratan bir görünüm sunuyor. UPS prizden İngiliz tipi prize, anahtardan dokunmatik dimmer'e kadar yüzlerce çeşit üründen oluşan çok geniş bir yelpazeye sahip Berker, mükemmel konforu evinize taşıyor.





Conduit Systems

(Boru ve Spiral Sistemleri)

- Metric Thread Conduit System (Metrik Diş Boru Sistemi)
- Flexible Conduit System (Flexible Boru Sistemi)
- NPT Thread Conduit System (NPT Diş Boru Sistemi)

Trunking Systems

(Kablo Kanalları)

- Flat Lid Trunking System (Düz Kapaklı Trunking Sistemi)
- 15° Apex Lid Trunking System (15° Eğimli Kapaklı Trunking) Sistemi)
- Lighting Trunking System (Aydınlatma Trunking Sistemi)



Cable Tray Systems

(Kablo Tava Sistemleri)

- Medium Duty Straight Edge Cable Tray (Orta Seri Düz Kenar Kablo Tavası)
- Medium Duty Return Flange Cable Tray (Orta Seri Bükümlü Kablo Tavası)
- Heavy Duty Return Flange Cable Tray (Ağır Seri Bükümlü Kablo Tavası)
- European Style Cable Tray (Avrupa Stili Kablo Tavası)
- Wire Basket Cable Tray (Tel Sepet Kablo Tavası)



Screwed Lid Enclosures

(Şalter ve Buton Kutuları)

- Push - Button Enclosures (Push Button Kutuları)
- Terminal & Control Enclosures (Klemens ve Kontrol Kutuları)
- Rotary Switch Isolator Enclosures (IP66 Şalter Kutuları)
- 15° Sloping Roof Control Stations (15° Eğimli Kapaklı Şalter Kutuları IP66)
- Emergency Stop Enclosures (Acil Stop Kutuları)
- Interlocked Switch & Socket Enclosures (Kilitli Anahtar ve Priz Kutuları)
- Switched Sockets & Back Boxes (Anahtar Priz ve Kasalar)

Hinged Door & 19" Rack Cabinets

(Rack Cabinets)

- Cabinets with Plain Doors (Düz Kapılı Panolar)
- Cabinets with Windows Doors (Cam Kapılı Panolar)
- 19" Rack Cabinets (19" Rack Kabinler)

GAS DIŞ (UNI ISO 228)					
DIŞ TIPI	DIŞ ÇAPID	DIŞ AKSID1	DIŞ DİBİ D2	DIŞ ARALIĞI P	DIŞ ADEDİ Z
G 1/4"	13,157	12,301	11,445	1,337	19
G 3/8"	16,662	15,806	14,950	1,337	19
G 1/2"	20,955	19,793	18,631	1,814	14
G 3/4"	26,441	25,279	24,117	1,814	14
G 1	33,249	31,770	30,291	2,309	11
G 1 1/4"	41,910	40,431	38,952	2,309	11
G 1 1/2"	47,803	46,324	44,845	2,309	11
G 2	59,614	58,135	56,656	2,309	11
G 2 1/2"	75,184	73,705	72,226	2,309	11
G 3"	87,884	86,405	84,926	2,309	11
G 4"	113,030	111,551	110,072	2,309	11

NPT DIŞ (ANSI B1.20.1)				
DIŞ TIPI	DIŞ ÇAPID	DIŞ DİBİ D2	DIŞ ARALIĞI P	DIŞ ADEDİ Z
NPT 1/4"	13,716	12,7635	1,411	18
NPT 3/8"	17,145	16,1925	1,411	18
NPT 1/2"	21,336	20,1115	1,814	14
NPT 3/4"	26,670	25,4455	1,814	14
NPT 1	33,401	31,9100	2,208	11,5
NPT 1 1/4"	42,164	40,6730	2,208	11,5
NPT 1 1/2"	47,800	---	2,208	11,5
NPT 2"	60,325	58,8340	2,208	11,5
NPT 2 1/2"	73,025	70,8817	3,175	8
NPT 3"	88,900	86,7567	3,175	8
NPT 4"	114,300	112,1567	3,175	8

PG DIŞ (DIN 40430)					
DIŞ TIPI	DIŞ ÇAPID	DIŞ AKSID1	DIŞ DİBİ D2	DIŞ ARALIĞI P	DIŞ ADEDİ Z
PG 7	12,50	11,89	11,28	1,27	20
PG 9	15,20	14,53	13,36	1,41	18
PG 11	18,60	17,93	17,26	1,41	18
PG 13,5	20,40	19,73	19,06	1,41	18
PG 16	22,50	21,83	21,16	1,41	18
PG 21	28,30	27,54	26,78	1,588	16
PG 29	37,00	36,24	35,48	1,588	16
PG 36	47,00	46,24	45,48	1,588	16
PG 42	54,00	53,24	52,48	1,588	16
PG 48	59,30	58,54	57,78	1,588	16

METRİK DIŞ (EN 60423)				
DIŞ TIPI	DIŞ ÇAPID	DIŞ AKSID1	DIŞ DİBİ D2	DIŞ ARALIĞI P
M12	12	11,026	10,376	1,5
M16	16	15,026	14,376	1,5
M20	20	19,026	18,376	1,5
M25	25	24,026	23,376	1,5
M32	32	31,026	30,376	1,5
M40	40	39,026	38,376	1,5
M50	50	49,026	48,376	1,5
M63	63	62,026	61,376	1,5

NOT : Ölçüler "mm" olarak verilmiştir. Kesit resimleri ölçeksizdir. Belirtilen ölçüler, pano (erkek) tip dişlerini kapsamaktadır.

AĞIRLIK		
1 ons (oz)	= 437,5 grains	= 28,350 g
1 pound (lb)	= 16 oz	= 0,4536 kg
1 stone	= 14 b	= 6,35 kg
1 ton	= 2,240 lb	= 0,0161 t
1 gram (g)	= 1,000 mg	= 0,0353 oz
1 kilogram (kg)	= 1,000 g	= 2,2046 lb
1 ton	= 1,000 kg	= 0,9842 ton

UZUNLUK		
1 inch	= 0,027 yard	= 2,54 cm
1 ft	= 12 inch	= 0,31 m
1 yard	= 3 ft	= 0,91 m
1 mil	= 5,280 ft	= 1,60 km
1 cm	= 0,032 ft	= 0,39 inch
1 m	= 36 inch	= 1,09 yard
1 km	= 1,760 yard	= 0,62 mil

HACİM		
1 kübik yard	= 27 cu ft	= 0,77 m3
1 pint (pt)	= 4 gills	= 0,57 L
1 galon (gal)	= 8 pt	= 4,55 L
1 desimetreküp	= 1,000 cm3	= 0,04 cu ft
1 metreküp (m3)	= 1,000 dm3	= 1,31 cu yd
1 litre (L)	= 1 dm3	= 0,22 gal

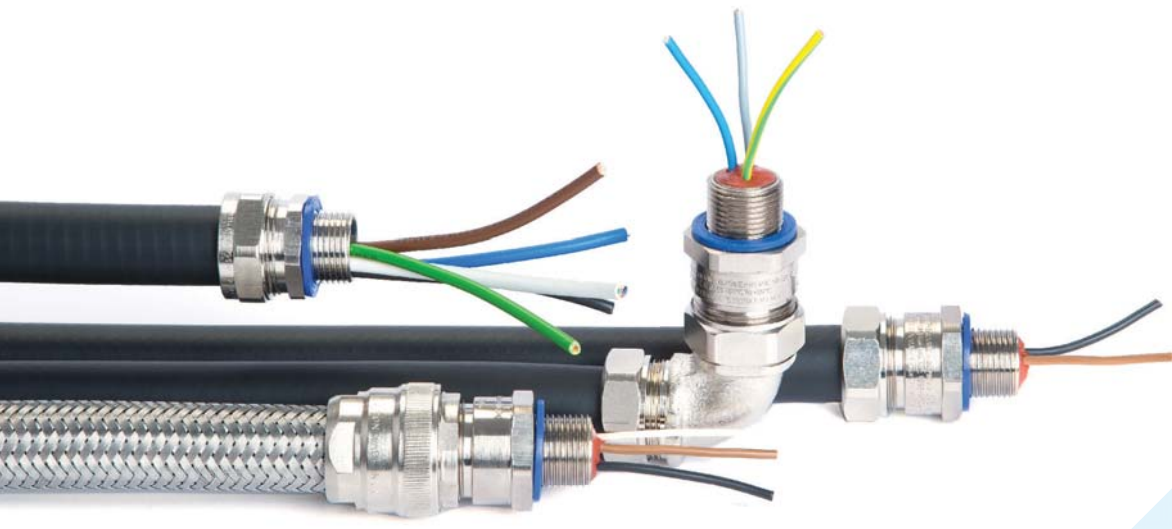

 **DELTA***FLEX*
Spiral Boru & EMT Boru & Exproof Malzemeler

📍 Barbaros Mah. Mimar Sinan Cad. No: 103 Batı Ataşehir / İstanbul

📞 0549 463 82 00

☎ 0216 317 68 18

✉ info@deltafleks.com

🌐 www.deltafleks.com